



Fusion Nuclear Technology
Modeling, Analysis and Experiments

Briefing to
Robert Price and Robert Kratzke
6 May 1993

Mohamed Abdou

Zinovy Gorbis

René Raffray

Tetsuaki Takeda

Fatollah Tehranian

Mark Tillack

Alice Ying

Robert Abelson

Alya Badawi

Seungyon Cho

Sasha Gaizer

William Kuan

Neil Morley

Faiz Sherman

Mingjie Xu

— Agenda —

Fusion Nuclear Technology Activities

Introduction M. Abdou 10 min

ITER Activities (50 min)

ITER Blanket Design R. Raffray 15 min

Tritium Transport Modeling A. Badawi 15 min

Fuel Cycle Modeling A. Ying 10 min

ITER Divertor Engineering Design M. Tillack 10 min

Base program Activities (60 min)

Solid Breeder Blanket Thermal Control M. Tillack 35 min

High Temperature Bed Thermomechanics F. Tehranian 10 min

Liquid Metal Divertor N. Morley 15 min

Phase Change Divertor Cooling R. Raffray 10 min

Lab Tours Tillack, Tehranian 30 min
Morley

ITER Blanket Design Activities

Overview of ITER Blanket Design Activities at UCLA

The UCLA contribution to the U.S. ITER Home Team Design activities for FY93 has focused on:

- Analysis of particulate flow blanket
- Evaluation of helium cooling of the ITER first wall, in collaboration with General Atomics

However, during this transition UCLA has been very flexible, contributing to other tasks as they are defined based on the Central Team preference and/or request, such as:

- Help in preliminary analysis of liquid metal blanket concept for ITER

Helium Coolant for ITER: Motivation

- A self-cooled liquid metal blanket concept has been proposed by the ITER JCT
- It has attractive features including: 1) the ability to maintain the FW temperature > 300 C; and 2) the possibility of converting from non-breeding to breeding by changing the liquid metal
- Three key concerns exist:
 1. Reactivity of both major tritium producing liquid metal options, Li and LiPb; concern can be attenuated by excluding water in the reactor
 2. Electrical Insulator
 - Feasibility issue for the first wall
 - R&D is required and should be done
 - However, success can not be guaranteed
 3. Liquid metal spill into the plasma chamber
- Therefore, it is crucial that a credible backup for first wall cooling be found and pursued
- Helium offers many advantages and is an attractive option for such a coolant

Helium Coolant for ITER: Advantages

Helium offers several major advantages:

- **Inertness:** safety-wise, it is highly rated as evidenced by the recent White Paper on safety from the US safety experts
- **Virtual decoupling of pressure and temperature.** This allows the first wall temperature to be changed and optimized during operation (without change in the He pressure) for:
 - improving plasma performance
 - optimum structural material resistance to radiation effect
- In case of "spill" to the plasma chamber, no special cleanup is needed, in contrast to all other coolants

Helium Coolant for ITER: Perceived Concerns

- Major perceived concerns for helium are based on previous studies of high-power density reactors. These concerns are alleviated in the ITER context as shown below:

Concern 1:

Helium needs to be operated at high pressure for acceptable thermal-hydraulics performance, which causes reliability and leakage concerns.

Answer:

- ITER power density is lower than typical power densities associated with past conceptual reactor design studies. Thus, helium can be operated at moderate pressure (20 atm).
- This pressure is within the pressure level that would result in damage of the vacuum vessel in case of catastrophic rupture.
- Furthermore, it can be shown that the helium leakage concern can be alleviated by designing such that no welds or brazes are in contact with the pressurized coolant.

Helium Coolant for ITER: Perceived Concerns (cont.)

Concern 2:

Reduction in shielding effectiveness due to void imposing a penalty in particular for inboard shielding

Answer:

- A helium-cooled first wall can be incorporated with modest change in blanket design so that there is:
 - 1) no change in the shield effectiveness,
 - 2) no change in the total first wall/blanket shield thickness at the inboard.

Concern 3:

Helium manifolding requires more space than available in the inboard

Answer:

- All manifolding is done at the top and bottom within the available space.

Helium Cooling of the Divertor

- If helium is used to cool the first wall, it should also be used to cool the divertor
- Indications from the ITER JCT are that the divertor heat loads would be significantly lower than typically considered ($\sim 5\text{MW/m}^2$).
- A survey of potential cooling concepts indicate that divertor cooling with helium is possible with conventional designs for heat fluxes of up to 5 MW/m^2 . Utilization of heat transfer enhancement techniques would enable removal of heat fluxes of up to 20 MW/m^2 .

Schematics of Toroidal Cross-Section of First Wall Channel Assembly and of its Integration with the Blanket Module

PLASMA SIDE

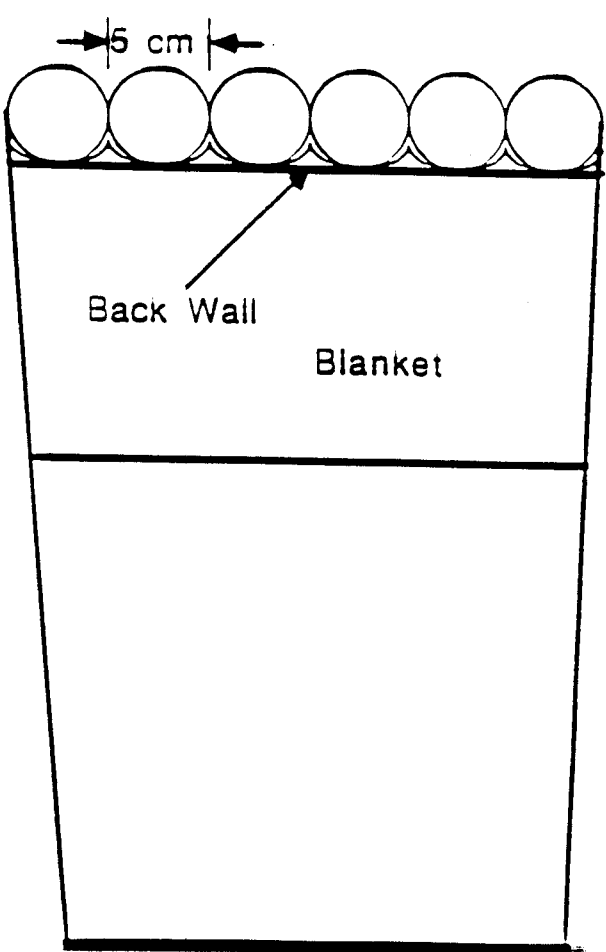
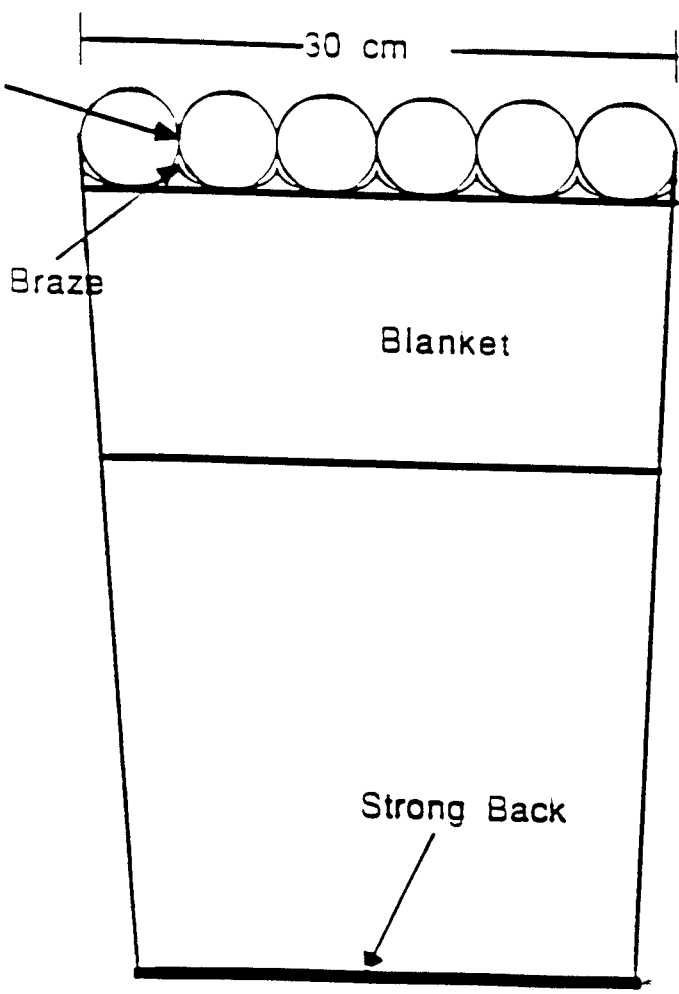
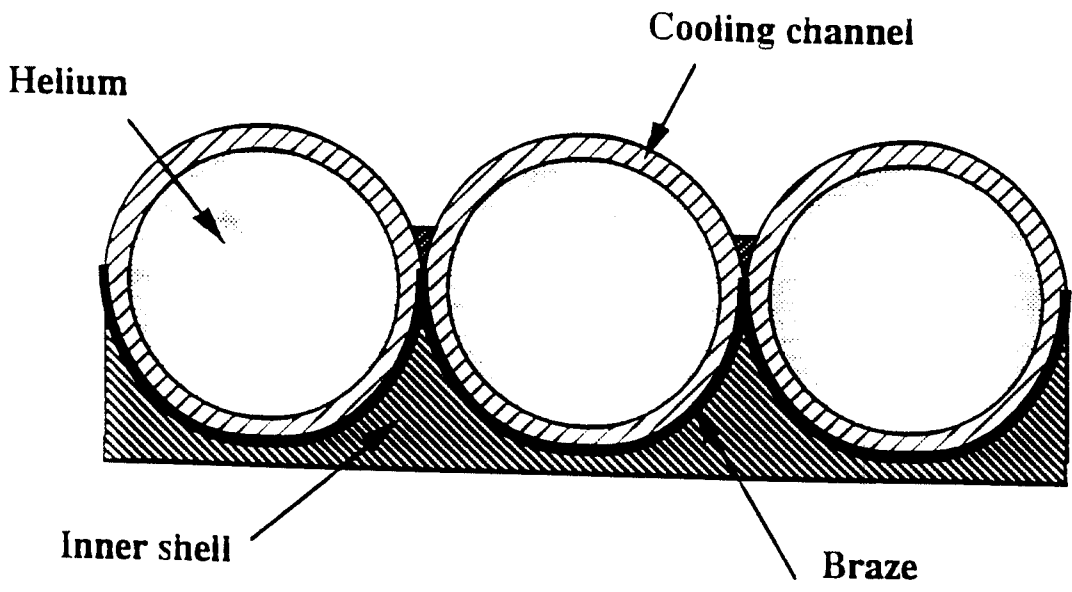

Assumed Reactor Parameters and Calculated Operating Parameters of Example Helium-Cooled First Wall Design Concept

First Wall Dimensions:

Total First Wall Area	1376 m ²
Length of Poloidal Channel	~ 12.5 m
Channel diameter at mid-plane	5 cm
Plasma-side channel wall thickness at mid-plane	4 mm
Blanket module width	30 cm

Power Dependent Parameters:

Fusion Power (MW)	1720	3440	
Average neutron wall load (MW/m ²)	1	2	
Average surface heat flux (MW/m ²)	0.125	0.25	
Peaking factor: Maximum	1.4	1.4	
Minimum	0.5	0.5	
Ave. Heat Generation in FW Structure(MW/m ³)	<u>10</u>	<u>20</u>	

Helium coolant:

Inlet pressure (MPa)	2	2	2	4
Inlet temperature (C)	250	200	93	200
Outlet temperature (C)	400	350	243	350
Overall pressure drop (MPa)	0.05	0.19	0.16	0.09
Overall pumping power (MW)	10	76	49	19
Maximum velocity (m/s)	72	134	119	72

First wall temperature (C):

Minimum	300	300	200	300
Maximum	<u>455</u>	<u>540</u>	<u>438</u>	<u>540</u>

Helium Coolant for ITER: Summary

- The possibility of cooling the ITER first wall with helium has been assessed:
 - Helium cooling of the ITER first wall poses no feasibility issues and is a viable option
- An example first wall concept consists of parallel poloidal channels with once through cooling with no welds in contact with the coolant
- In this configuration, helium can operate at moderate pressure (20 atm) to remove the first wall thermal power with reasonable pumping power (~10 MW for normal operation equivalent to 1 MW/m² wall load and ~76 MW for operation at maximum power level corresponding to 2 MW/m² wall load)
- A channel diameter of 5 cm and thickness of 4 mm results in acceptable stress levels at midplane even under high power operation
- The channel assembly can withstand an assumed disruption-induced radial pressure of 2 MPa based on a 30-cm simply-supported span model

Helium Coolant for ITER: Summary (cont.)

- **The FW temperature can be kept within its desirable temperature window (e.g. in the range 200-440C or 300-540C) for operation over a range of power levels (accounting for peaking factors of 0.5 and 1.4, $P_w = 2 \text{ MW/m}^2$, $P_s = 0.25 \text{ MW/m}^2$). In addition, helium can be optimized during operation since it is virtually decoupled from pressure**
- **The helium temperature rise is kept to 150 C to maintain reasonable levels of thermal stress and deformation**
- **This assessment indicates that helium provides an attractive option for ITER first wall cooling, which would enhance the potential of technical success and safety of a self-cooled liquid metal blanket**

Particulate Flow Blanket

APPROACH

- Conduct a Survey of Existing Blanket Designs Using Particulate Flow
 - SOMBRERO. HERCULES. UWMAK-III...

- Identify and Evaluate Key Issues Specific to Blanket, Including:
 - Heat transfer
 - Erosion
 - Flow control
 - Tritium (inventory, release, permeation)

- =

- Based on a Preliminary Assessment of Issues, Select Concept(s) with Best Potential for ITER Application and Perform an Initial Design Analysis

- Perform a Preliminary Assessment of Particulate Flow Blanket for ITER Application, of Potential for DEMO Extrapolation, and of R&D Needs

Gas Particulate Flow Systems

Advantages as Compared to Pure Gas

- High volumetric heat capacity
- Lower pumping power requirements for the same pure gas pressure
- Smaller pipe ducts for cooling systems

Particulate flow systems can be classified roughly into three categories based on the solid concentration:

- Dilute-phase pneumatic conveyor for particle transport
 - Particles flow either upward or downward; solid concentration is less than 5%.
- Dense-phase circulating fluidized beds for combustion boiler
 - Particles flow upward in combustion chamber; solid concentration varies between 5 to 20%.
 - Complicated hydrodynamic phenomena along the flow direction arising from stratification of solids and cluster formation
- Dense moving beds
 - Particles flow downward; solid concentration approaches 60%.

Broad data base exist from chemical, combustion, mining, and processing industries

Application of the available knowledge and technology to the blanket designs has to take into consideration:

- Geometric Limitation and Remote Maintenance Requirements
- Tritium Breeding and Shielding Requirements
- Need for Plasma Surface Heat Flux Removal

MOBILE SOLID BREEDER BLANKET DESIGN CONCEPTS: REVIEW

Concept	Moving Bed	Dilute Suspension
Representative Designs	Gravity Circulated Solid Breeder Blanket UWMAK-III /1976 SOLASE-II /1977 SOMBRERO / 1991	Helium-Cooled Lithium Compound Suspension for ITER/ 1988 HERCULES Design / 1988 (ARIES) JAERI -Solid Particulate Cooled Blanket for SSTR / 1992
Coolant	Li ₂ O/Gas	He or CO ₂ + Particulate (SiC, Li ₂ O, Li ₄ SiO ₄ , ---)
Mobile solid volume fraction	~ 60 %	1-5%
Carry gas pressure	Low (< 1 atm)	High (> 50 atm for He, > 5 atm for CO ₂)
Coolant (Particle) velocity	< 0.5 m/s	12 m/s (HERCULES-I) 30 m/s in FW (JAERI-SSTR)
Attractive features	<ul style="list-style-type: none"> - Simple, low pressure blanket. - Choice of breeding or not - Accommodation of ⁶Li burn-up through refueling 	<ul style="list-style-type: none"> - Lower volumetric flow rate and pressure drop, and smaller pipe size when compared to pure gas - Choice of breeding or not - Accommodation of ⁶Li burn-up through refueling
Unfavorable features/Concerns	<ul style="list-style-type: none"> - Low heat transfer coefficient (separate first wall coolant needed) - Large solid breeder inventory - Particulate transport - Possibility of flow stoppage 	<ul style="list-style-type: none"> - Erosion - Integration with heat exchanger - Flow distribution

High Velocity Particle Impact Erosion

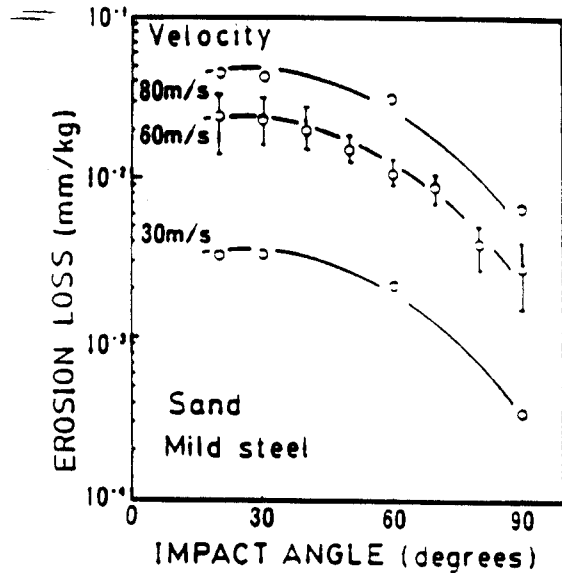
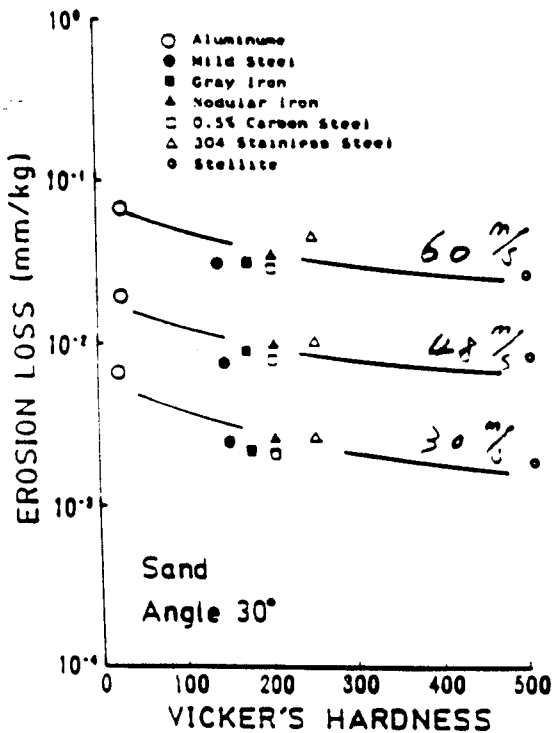
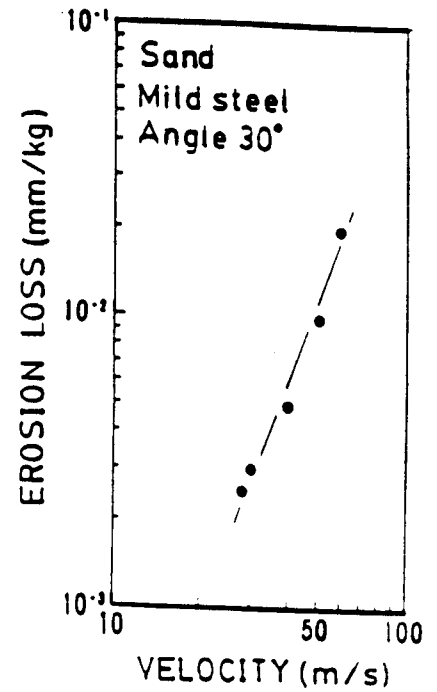
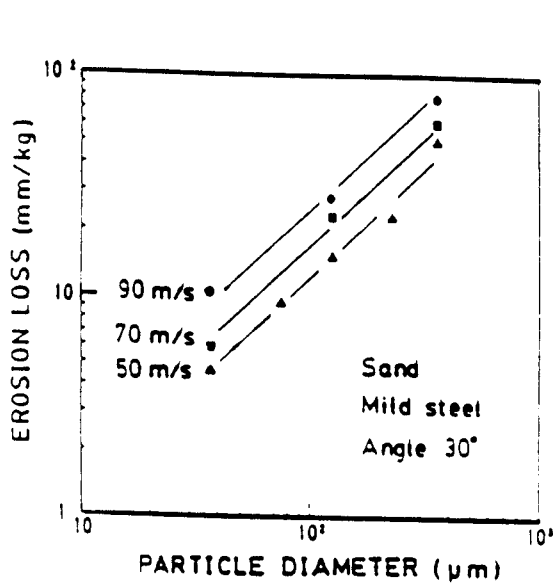

$$E \text{ (erosion depth per unit particle weight)} \propto V_p^{2.8} \mu_s^{-0.6} d H_v^{-0.4}$$

$$28 \text{ m/s} < V_p < 90 \text{ m/s}; 0.1 < \mu_s < 20; 23 \text{ μm} < d < 500 \text{ μm}; 30 < H_v < 500$$

E.g., for SSTR-2 design parameters:

FW coolant velocity = 30 m/s, μ_s = solid to gas mass ratio = 13, d_p = 50 μm

SS erosion ~ 4 mm/day at impact angle of 60°

Dense Moving Bed Blanket Concept

Features

- Convertible from non-breeding to breeding
- Structurally integrated; simple shell (box) configuration
- Separate first wall coolant (moderate pressure He) for surface heat removal
- Low helium pressure (1 to 2 atm) particulate flow system
- Gravity-driven particulate flow would require inlet manifold at the top and outlet manifold at the bottom

PROS and CONS Relative to Stagnant Solid Breeder Blanket

- + Convertibility possibility
- + Simpler reactor blanket configuration
- + Minimum burn-up effects
- + Less danger of blanket overpressurization
- Complex loop systems (such as heat exchanger, particle transport) outside the vacuum vessel
- Lockup/stagnation concern
- Large inventory of solid breeder material

Heat Transfer for Flowing Packed Beds in Circular Tubes with Constant Wall Heat Flux

Ranges of experimental variables

Tube diameter, D mm	7.75, 13.8, 24.8
Average particle diameter d , μm	214, 505, 715
Wall heat flux q , W/cm^2	2.10-4.20
Average bed velocity, V , cm/s	0.9-15.3

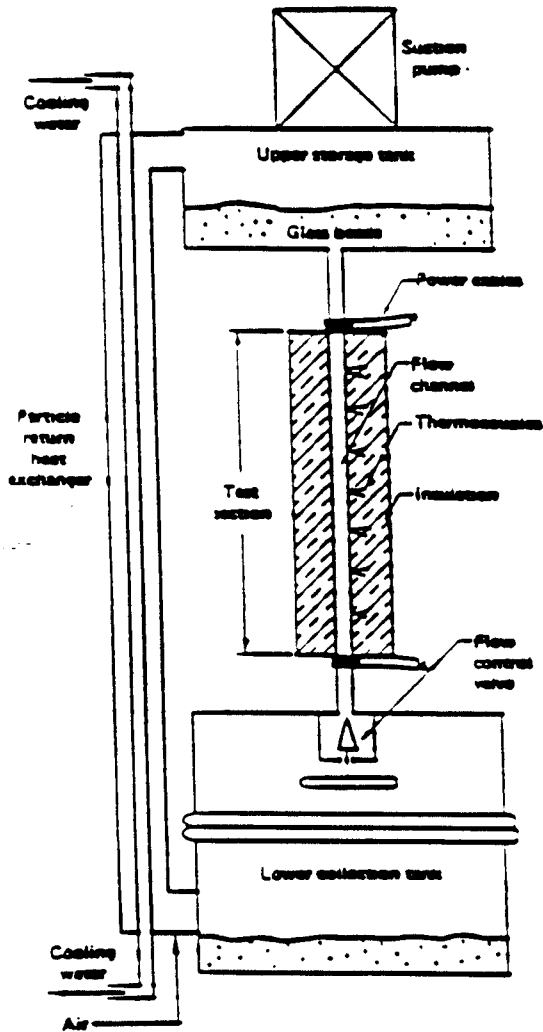

Schematic diagram of the test loop used by Nietert and Abdel-Khalik

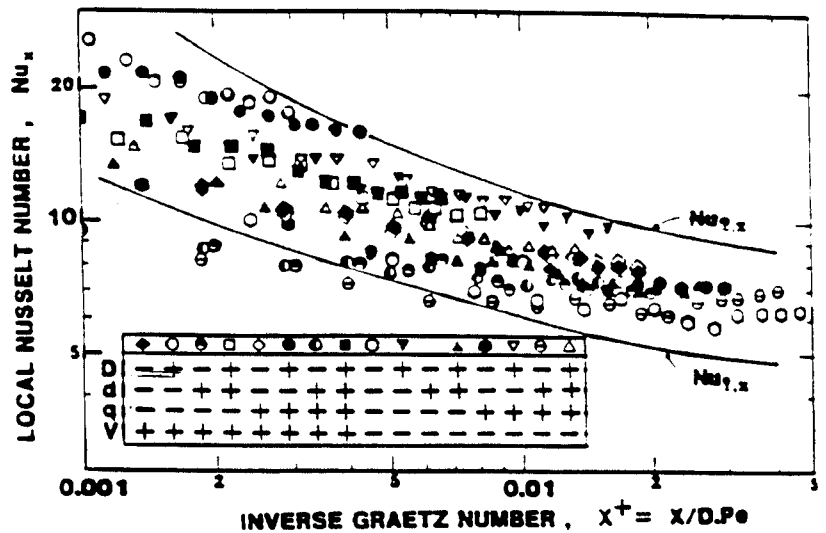

Variation of the local Nusselt number Nu_x with nondimensional distance x^+ for the different experiments selected in the factorial design

$$Nu_x = \frac{h_x D}{k_{eff}}$$

$$Pe = \frac{\rho_{eff} C_{eff} V D}{k_{eff}}$$

$$x^+ = \frac{x}{D Pe}$$

• For $\text{Li}_2\text{O}/\text{He}$ Moving Bed with 60% Packing:

$$Nu_x = 20 \text{ for } D = 0.05 \text{ m} \longrightarrow h_x = 530$$

Low Velocity Particle Impact Erosion

Dropping experiments:

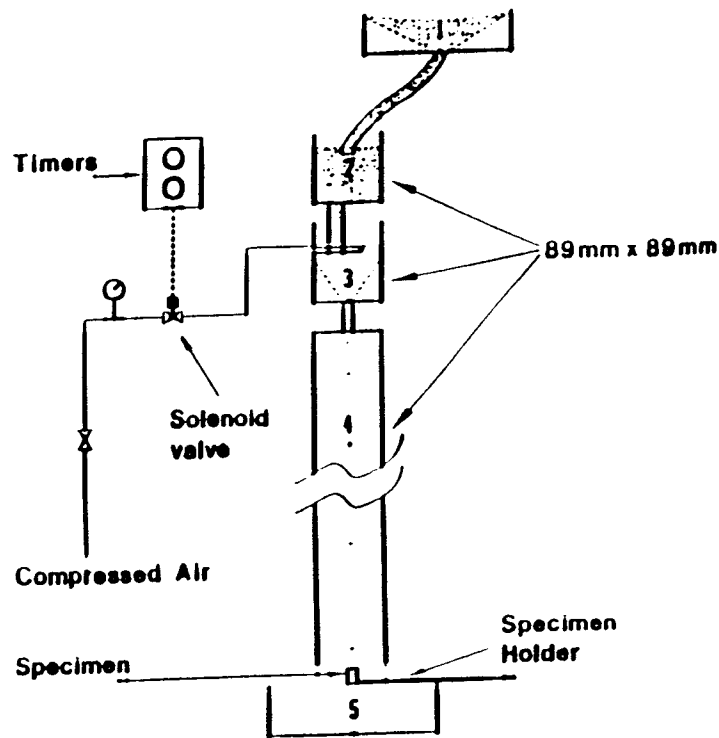

Schematic of particle dropping apparatus. (1) Storage funnel. (2) Particle level control section. (3) Particle release section. (4) Sheltered acceleration zone. (5) Collecting container.

Ranges of independent variables in dropping experiments

Variable	Symbol	Range
Particle impact velocity	v_p	2.2–5.0 m/s
Particle mass flux	M	2.4–5.7 kg/m ² s
Particle diameter	d_p	0.89–1.51 mm
Particle sphericity	Φ_p	0.86–1.0
Particle hardness	H_p	40–590 kg/mm ²
Impingement angle	θ	23–90°
Specimen material	—	Brass, aluminium, copper, stainless steel 316, carbon steel 1050, PVC, plexiglass

Fitted values of k and key material properties for specimens used in dropping experiments

Material	Young's modulus (GPa)	Hardness (kg/mm ²)	Av. erosion rate ($\mu\text{m}/100\text{ h}$) [†]	$k^‡$
Brass	97	155	238	8.0
Al 2011	70	98	250	8.4
Copper	115	132	126	4.2
SS 316	190	230	45	1.5
CS 1050	210	327	41	1.4
PVC	NA	27	246	NA
Plexiglass	NA	15	750	NA

[†] For $v_p = 5.0$ m/s, $M = 5.7$ kg/m² s, $\theta = 90^\circ$, silica sand particles of $\Phi_p = 0.91$ and $d_p = 1.0$ mm.

[‡] Units: ($\mu\text{m}/100\text{ h}$) (m/s)^{-2.3} (mm)^{-1.5} (kg/m² s)⁻¹.

Correlation based on experimental results:

$$E (\mu\text{m}/100\text{h}) = k M d_p^{1.5} v_p^{2.3} (1.04 - \phi) (0.448 \cos^{2.8} \theta + 1)$$

For moving bed blanket case: $E(\text{SS 316}) \sim 6 \mu\text{m}/100\text{ h}$

Flow Control and Distribution of Gravity-Driven Particulate Flow

To offset the effect of the radial distribution of nuclear heat generation rate in order to produce uniform coolant outlet temperature, it is necessary to control the particle velocities as a function of distance away from the FW.

For coarse, free flowing particles

- $B > 6 d_p \rightarrow$ uninterrupted flow
- $B = 6 d_p \rightarrow$ irregular discharge
- $B < 4 d_p \rightarrow$ flow is likely to stop completely due to mechanical arching at outlet

Flow Characteristics

- Pulsating nature
- Particles collide resulting in local rotation and translation in the lateral direction
- Free-fall arch

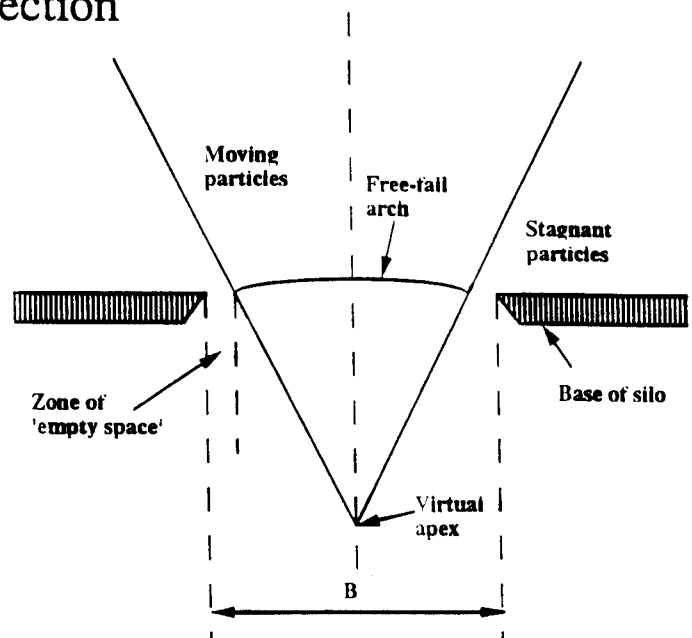

The mass discharge rate can be correlated as:

$$W = 0.58 \rho_p g^{0.5} (B - k d_p)^{2.5}$$

Our initial experimental data confirm that, in a prototypical blanket geometry, the mass flow rate can be adjusted by varying the size of the discharge opening.

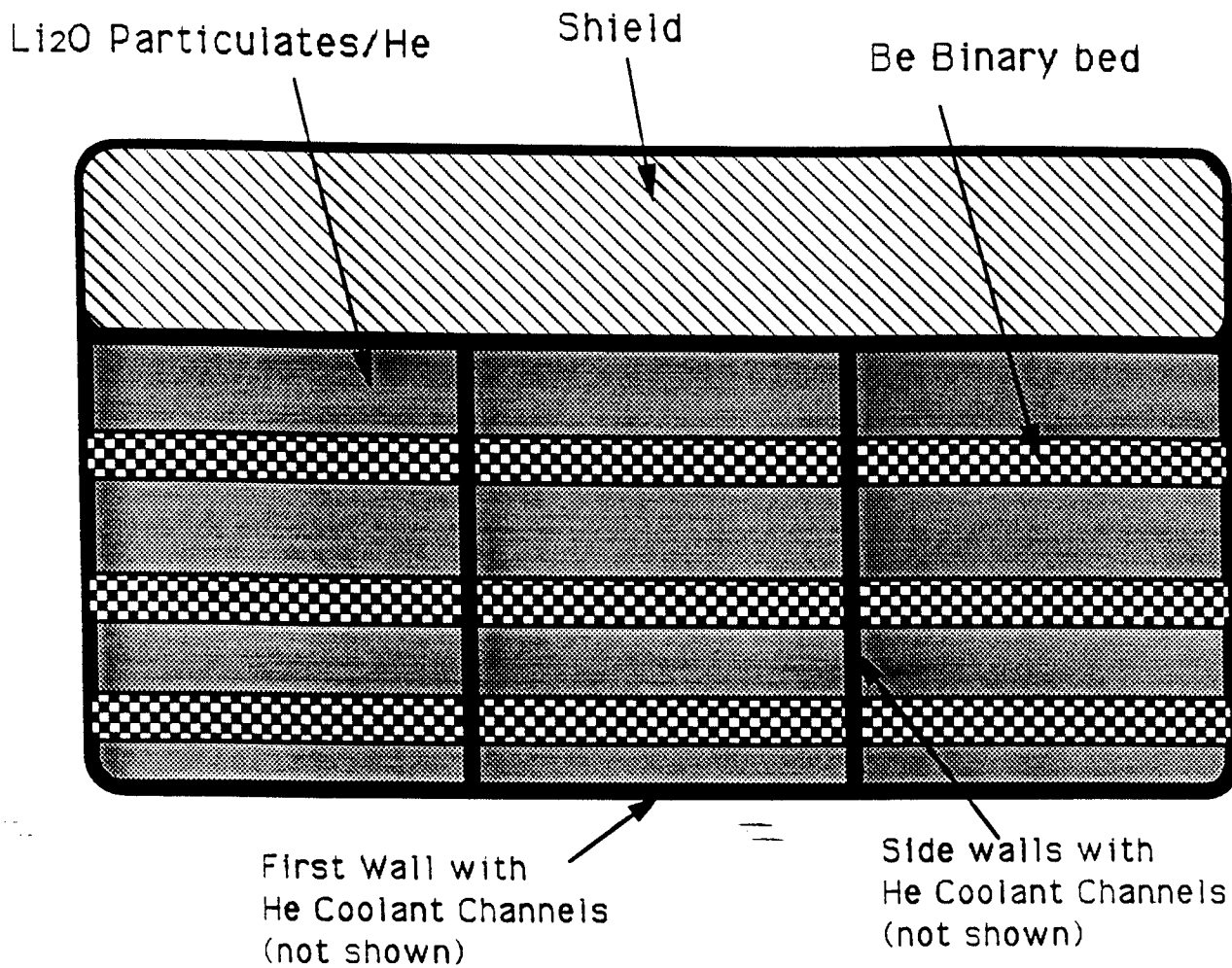

Toroidal Cross Section of Example Blanket Configuration for ITER

(The Li₂O and Be regions are sized based on keeping the Li₂O temperature under 800 C and the Be temperature under 600 C)

Example Particle Transport Loop

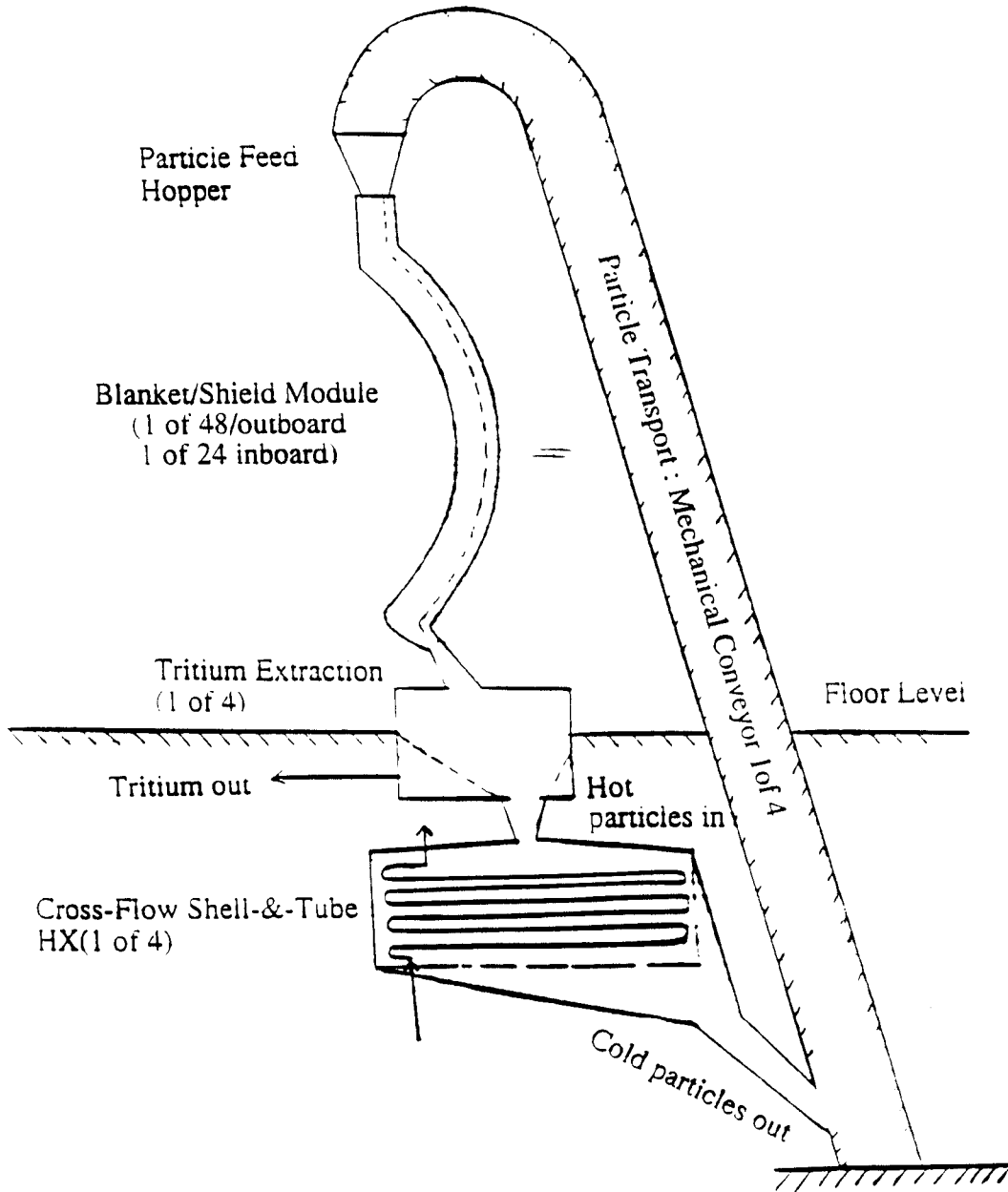

ITER-Like Parameters Assumed for the Initial Analysis

Average neutron wall load = 2 MW/m²

Average plasma surface heat flux = 0.2 MW/m²

Blanket poloidal length = 12 m

Blanket region radial thickness = 50 cm

Major radius ~ 9 m

Minor radius ~ 3 m

Number of TF coils = 24

Example Parameters for Moving Bed Particulate Flow Blanket

Materials

Breeder/Blanket Coolant:	Li ₂ O particulates/He
Multiplier:	Be (Binary Bed)
Structural Material:	SS 316

Li₂O/He Particulate Flow

Particle size:	0.5 mm
Packing density:	0.55
Channel Minimum Dimension:	5 cm
Inlet Temperature:	250 C
Outlet Temperature:	450 C
Maximum Velocity:	0.42 m/s
Total Mass Flow Rate:	~5000 kg/s
Feeding/Discharge Pipe Dia. per Module	~ 25 cm (outboard, 1 of 48) ~ 20 cm (inboard, 1 of 24)
System pressure:	~ 2 atm
Tritium inventory:	~ stagnant CB blanket
1-D TBR:	1.34
q''' _{max} (Li ₂ O):	20 MW/m ³
q''' _{max} (Be):	8 MW/m ³
Tritium permeation rate:	~ 70 Pa H ₂ O added to minimize permeation
Heat Transfer Coefficient:	~ 600 W/m ² -K
Maximum Breeder Temperature:	590 C
Maximum Be Temperature:	600 C

First Wall Structure/Coolant

Separate Coolant:	He
Pressure:	20 atm
First Wall region Thickness:	5 cm
Pipe Diameter:	4 cm
Inlet Temperature:	200 C
Outlet Temperature:	450 C
Average Velocity:	80 m/s
Heat Transfer Coefficient:	~ 1560 W/m ² -K
Maximum Structure Temperature:	600 C
Thermal Stress:	100 MPa

Moving Bed Blanket Design Issues and R& D Needs

- **Issues**

- Locations of Inlet/Outlet Manifolds (Top/Bottom)
- Space availability
A circular opening of about 25 cm is needed to remove a thermal power of 38 MW and a coolant temperature rise of 200 °C (assuming 48 modules).
- Accommodation of penetrations
- Out-of-reactor particle transport system design (mechanical or pneumatic)

- **Major R & D Needs**

- Erosion for prototypic geometry and conditions
- Flow Distribution/Control; Stoppage Prevention
- Heat Transfer Capability

Particulate Flow Blanket for ITER

Summary

- A moving bed configuration is preferred due mainly to erosion concerns with dilute suspension flow
- The attractiveness of such a concept is dependent on machine design space, penetration and access considerations
- Key issues have been identified
- A substantial data base exists from other industries, but blanket application would still require a large R&D effort due to the unique set of operating conditions and constraints.
- However, this class of blanket could still be attractive when compared to other convertible blanket alternatives.

Tritium Transport Modeling

Tritium Modeling at UCLA



Ceramic Breeders

- Development of MISTRAL, a state of the art, comprehensive model for tritium transport in ceramic breeders
- Used for ITER blanket analysis in US and Europe
- Used for analysis of experimental data, BEATRIX-II, TEQUILA

Single Crystals

- MISTRAL-SC has been developed specifically for modeling tritium transport in ceramic breeder single crystals
- Focus is on better understanding and characterization of fundamental property data based on analysis of experimental results
- Applied to analysis of recent LiAlO₂ results

- *Predict inventory in ITER blanket*
- *Predict inventory in reactor blankets*
- *Help understand time-dependent behavior*
- *help define ITER operating requirements*
- *Pre- and post-analysis of experiments*
- *Collaboration with national and international organizations*
- *Excellent topics for Ph. D. students, which allows field to benefit*

Beryllium

- Tritium inventory in Be can be substantial over the blanket life
- Be is considered as a candidate plasma facing material
- Comprehensive model is being developed for better understanding of tritium behavior in Be

Tritium Fuel Cycle

- A model is being developed in cooperation with LANL for estimating time-dependent tritium inventories and major species concentrations based on detailed characterization of each subsystem in the ITER fuel cycle

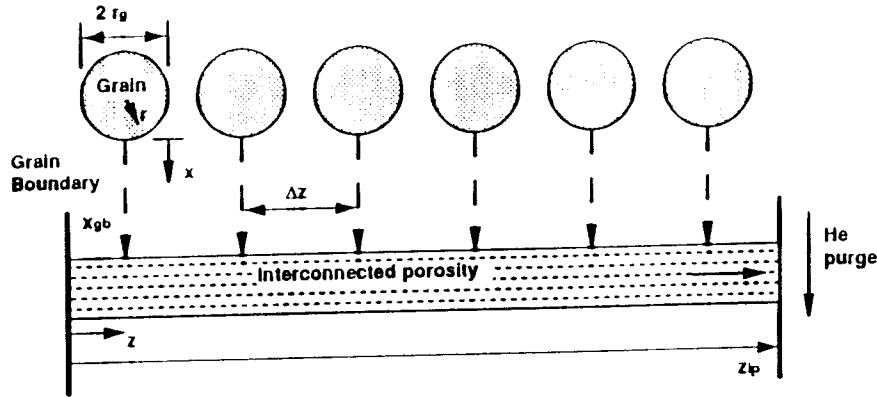

Schematic of MISTRAL Unit Cell

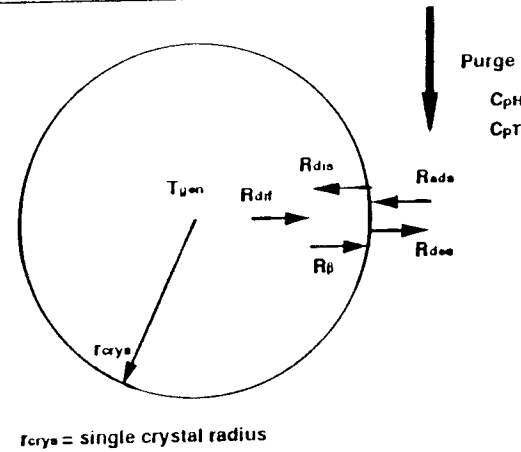

r_{crys} = single crystal radius

T_{gen} = Tritium generation in bulk
 R_{diff} = Tritium bulk diffusion flux
 Tritium/Hydrogen surface fluxes:
 R_{dis} = Dissolution flux
 R_p = Bulk to surface flux
 R_{des} = Desorption flux
 R_{ads} = Adsorption flux

C_{pH} = Hydrogen concentration in purge
 C_{pT} = Tritium concentration in purge

Schematic of MISTRAL-SC Model for Tritium Transport in a Solid Breeder Single Crystal

30

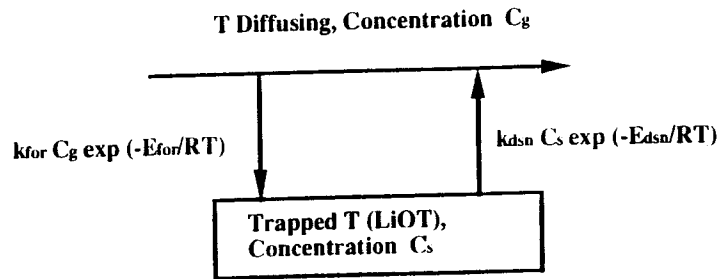

Schematic of Including chemical trapping in MISTRAL

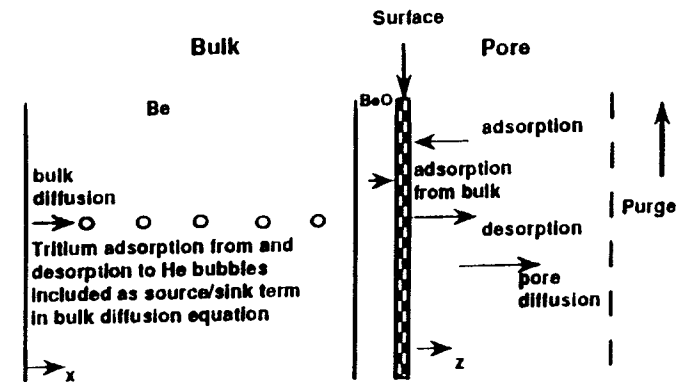

Schematic of Model for Tritium Transport in Be

- **MISTRAL-SC** has been used in the analysis of experimental data available on **LiAlO₂** single crystals.

Example Application of MISTRAL-SC: Analysis of Tritium Release from LiAlO₂ Single Crystal under 538, 777, and 950 °C Temperature Anneals

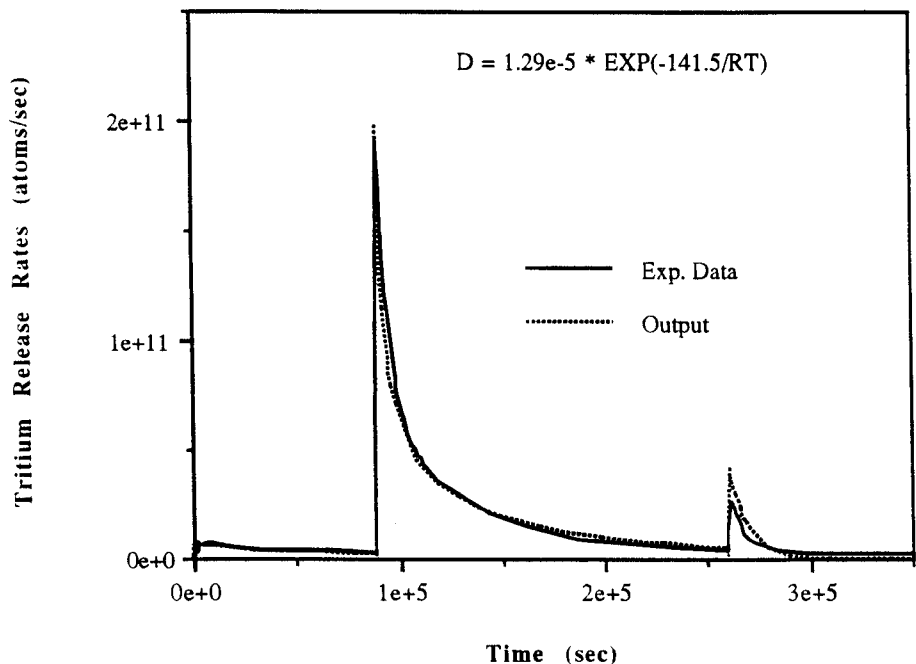

ANALYSIS OF BEATRIX-II Li₂O RING SPECIMEN USING MISTRAL

- **Using MISTRAL to Analyze Experiments on Ternary Ceramics Produces Good Results.**
- **However, for Li₂O, it Underpredicts the Tritium Inventory.**
- **The Analysis of BEATRIX-II Ring Specimen Indicates the Presence of Trapping in the Bulk.**
- **The Capability of Accounting for the Formation of LiOT in the Grains was Added to MISTRAL. It was then Used to Analyze BEATRIX-II Data.**
- **The Analysis was Divided into Three Parts:**
 - **Estimation of the end-of-life inventory**
 - **Estimation of the change in inventory due to transients**
 - **Calculation of the tritium release history in transient cases.**

- **Comparison of Inventory Estimates at Shutdown with the Measured Value Provides an Excellent Opportunity to Help Confirm the Analytical Findings.**

	End-Of-Life Inventory	Major Component
Measured	50 mCi	-----
MISTRAL No Trapping	1 mCi	Surface
MISTRAL Including Trapping	46 mCi	Bulk

- MISTRAL was Then Used to Predict the Change in Inventory Temperature and Purge Gas Composition Transients.**

MISTRAL predictions of the change of inventory for the BEATRIX-II ring sample.

Temperature (°c)	Purge Gas Composition	ΔI (mCi)	
		Model	Experiment
550 → 650	He + 0.1% H_2	-60	-48
650 → 550	He + 0.1% H_2	+60	+50
638 → 600	He + 0.1% H_2	+16.75	+28±54
600 → 550	He + 0.1% H_2	+37.27	+36±27
550 → 597	He + 0.1% H_2	-35.59	-24±19
640	He + 0.1% H_2 → He	903	12×10^3
640	He → He + 0.01% H_2	-825	2.5×10^3
640	He + 0.01% H_2 → He + 0.1% H_2	-78	2.65×10^3

- The Calculated Tritium Release was in Good Agreement with the Experimental Results for Temperature Transients

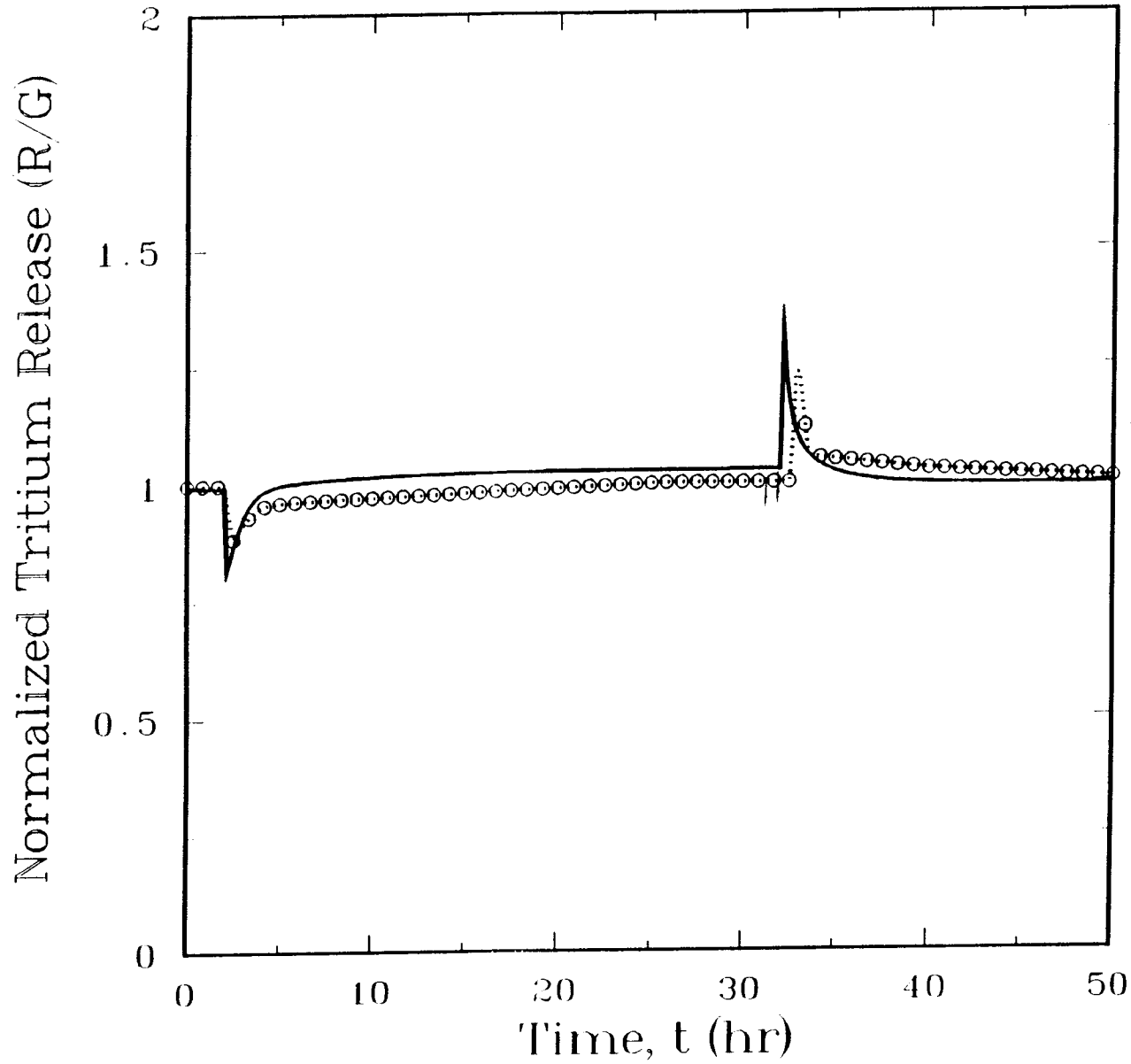

Example : Comparison of Predictions from Model with Experimental Results for Tritium Release from Beryllium

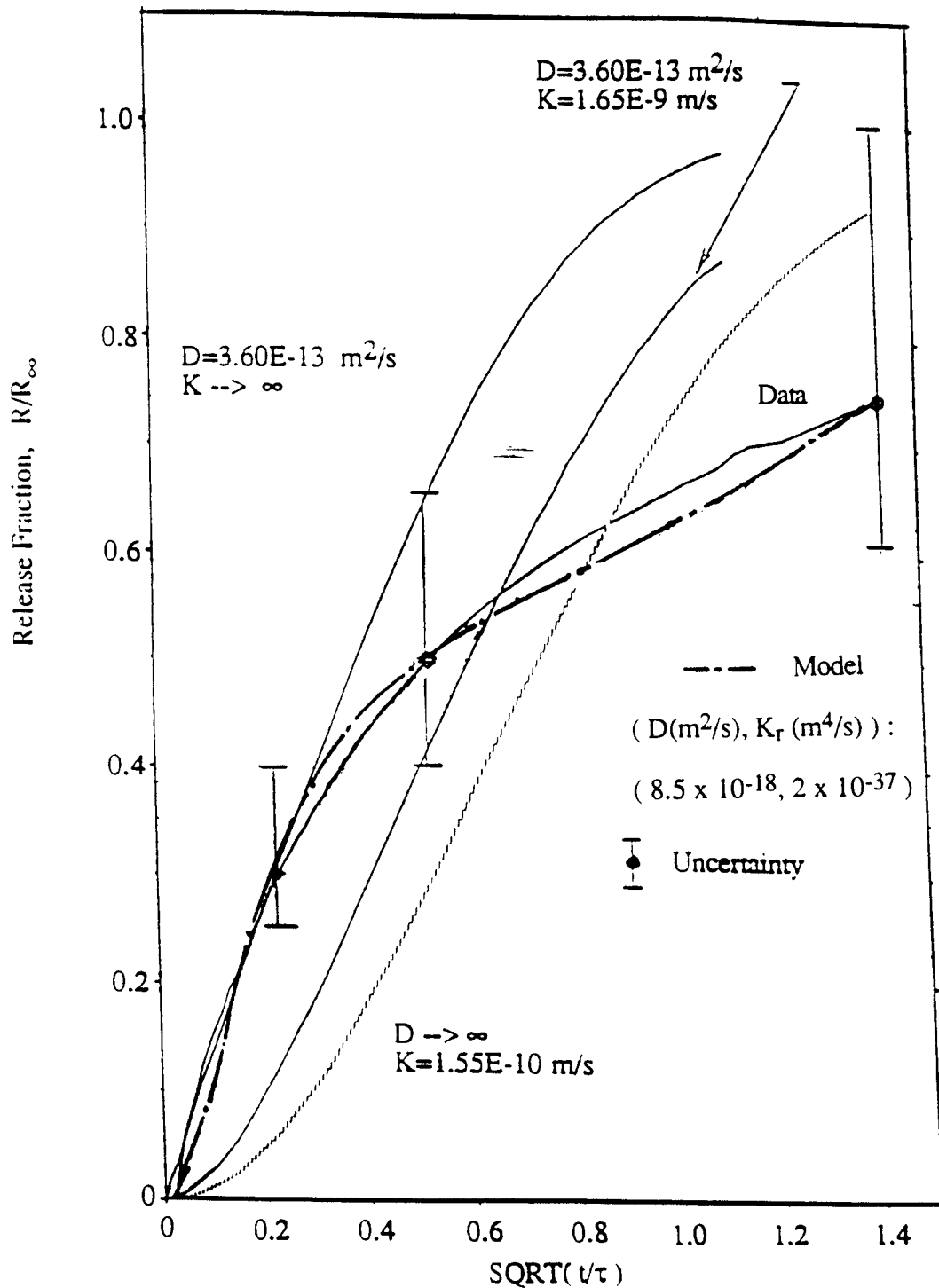

Tritium Release from Be (80% Dense, 0.045 wt% BeO)

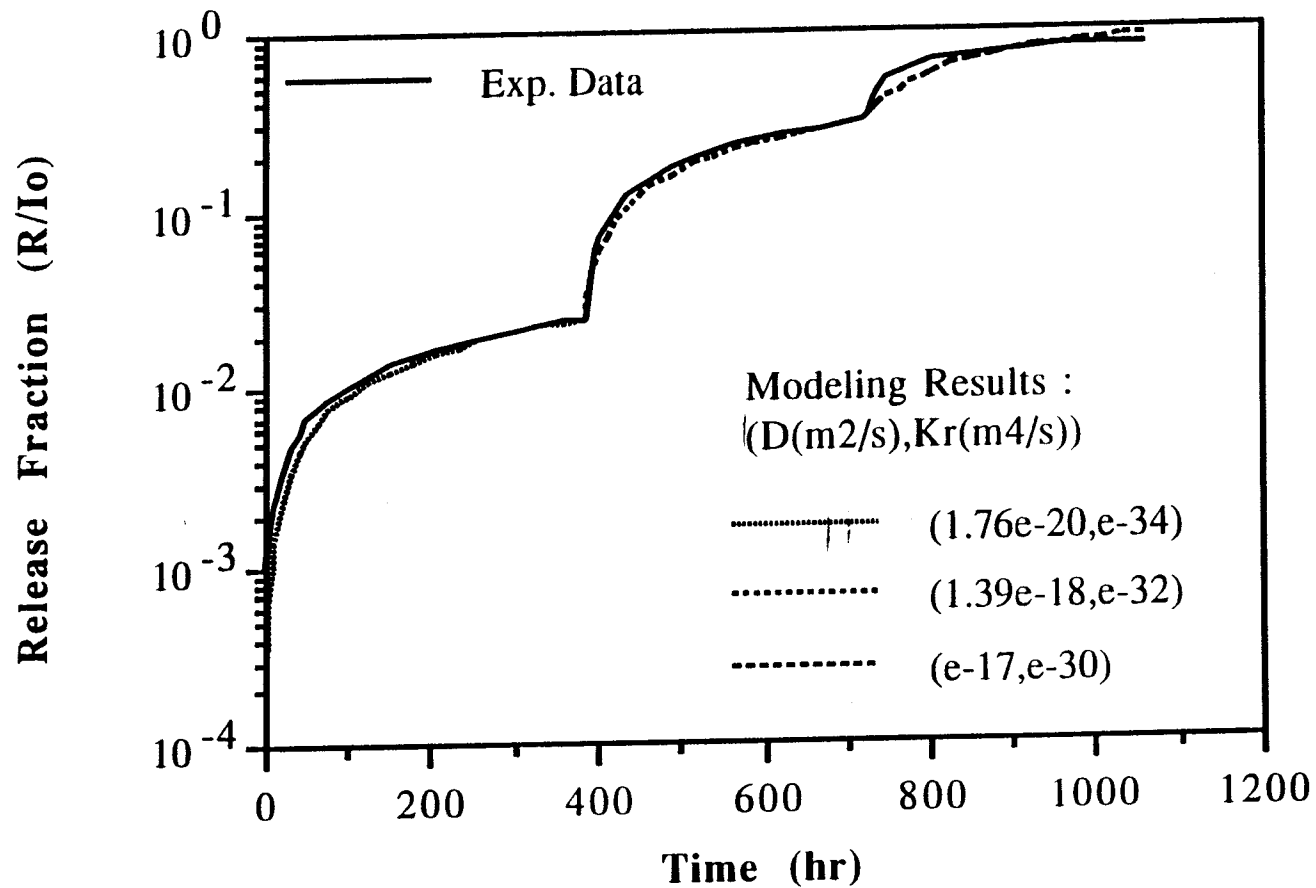

Dynamic Fuel Cycle Modeling

Introduction

- 1986-

Abdou et al.: dynamic modeling of a fusion reactor's fuel cycle using a tritium residence time approach, with the objective of determining the required tritium breeding ratio.

- Summer, 1992

Collaboration was established between UCLA, UC Berkeley and LANL to initiate a computer modeling effort on the fuel cycle, with UCLA and UC Berkeley focused on computer modeling, while LANL provided consultation, coordination and experimental data for code benchmarking.

The goal was to develop a time-dependent tritium system code using a detailed and realistic model for each fuel cycle subsystem.

- Present

Proposal to JCT to get US to take the lead on fuel cycle modeling for ITER.

LANL and UCLA will lead this effort.

Objectives of Dynamic Fuel Cycle Modeling

A dynamic tritium modeling effort aims to

- (1) accurately determine tritium flow rates and inventories everywhere in the reactor plant

The model must account for all ITER design options and various reactor operation scenarios: pulsing, continuous operations, short term shutdown (days), long term shutdown (weeks).

- (2) explore different methods and operating regimes to enhance ITER safety feature: minimizing tritium inventory and optimizing tritium usage.
- (3) allow evaluation of tritium fuel self-sufficiency conditions.

Plasma Exhaust Pumping

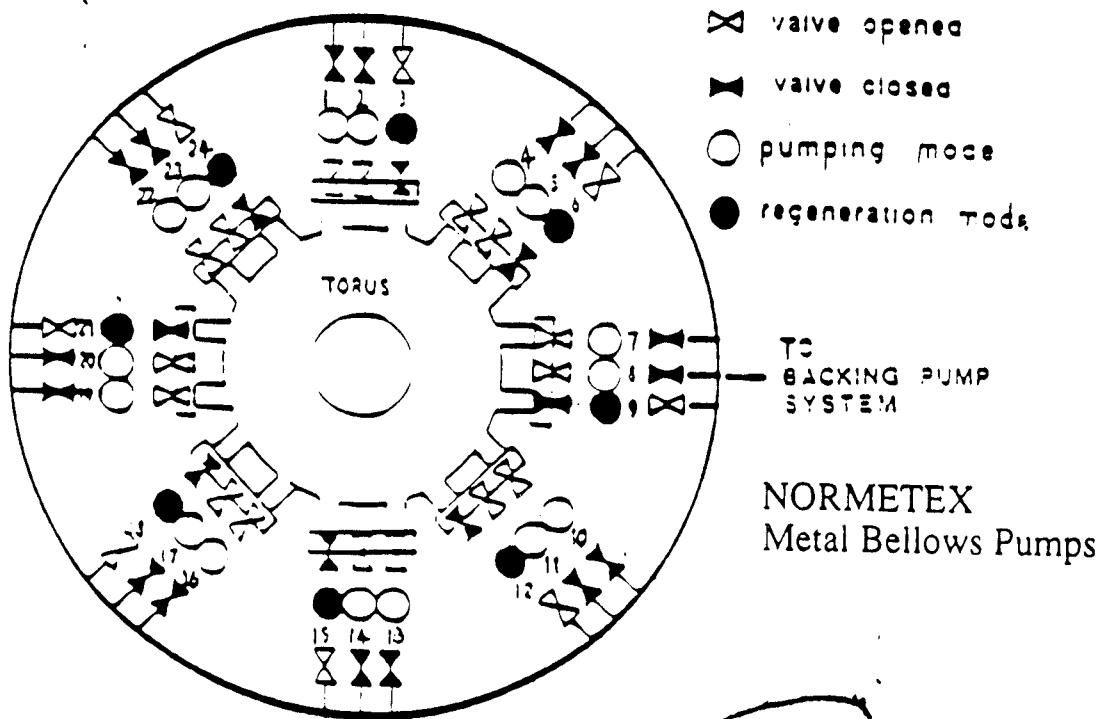

• Operating Scenario:

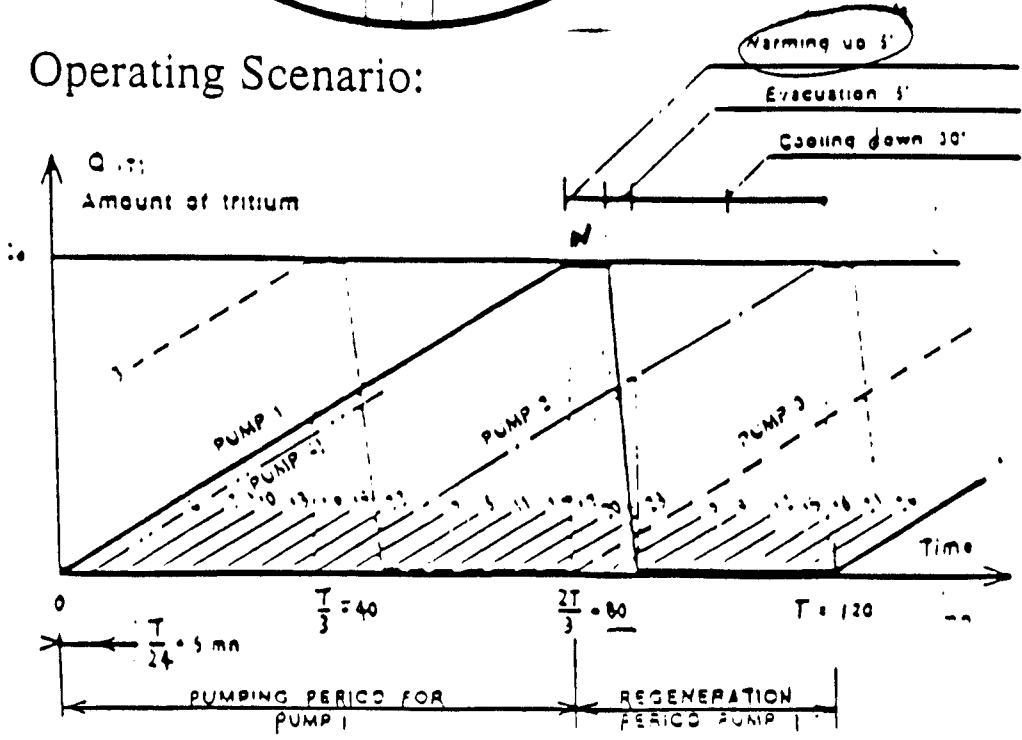

A modeling effort allows more economic exploration of processing options compared to the alternative of conducting experiments.

CODE DIAGRAM

Module Development

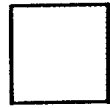

EXISTING MODULES

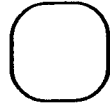

MODULES IN DEVELOPMENT

* UNIT OPERATION MODULES
CONSIST OF BOTH:
1) UNIT SCHEDULING MODULES
2) COMPONENT MODULES

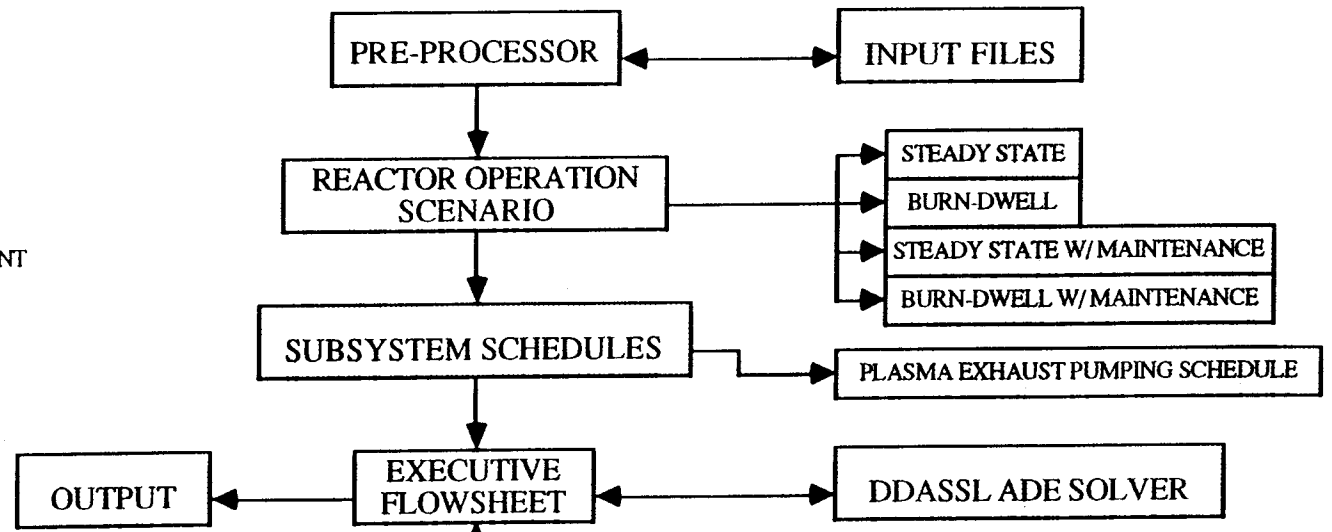

43

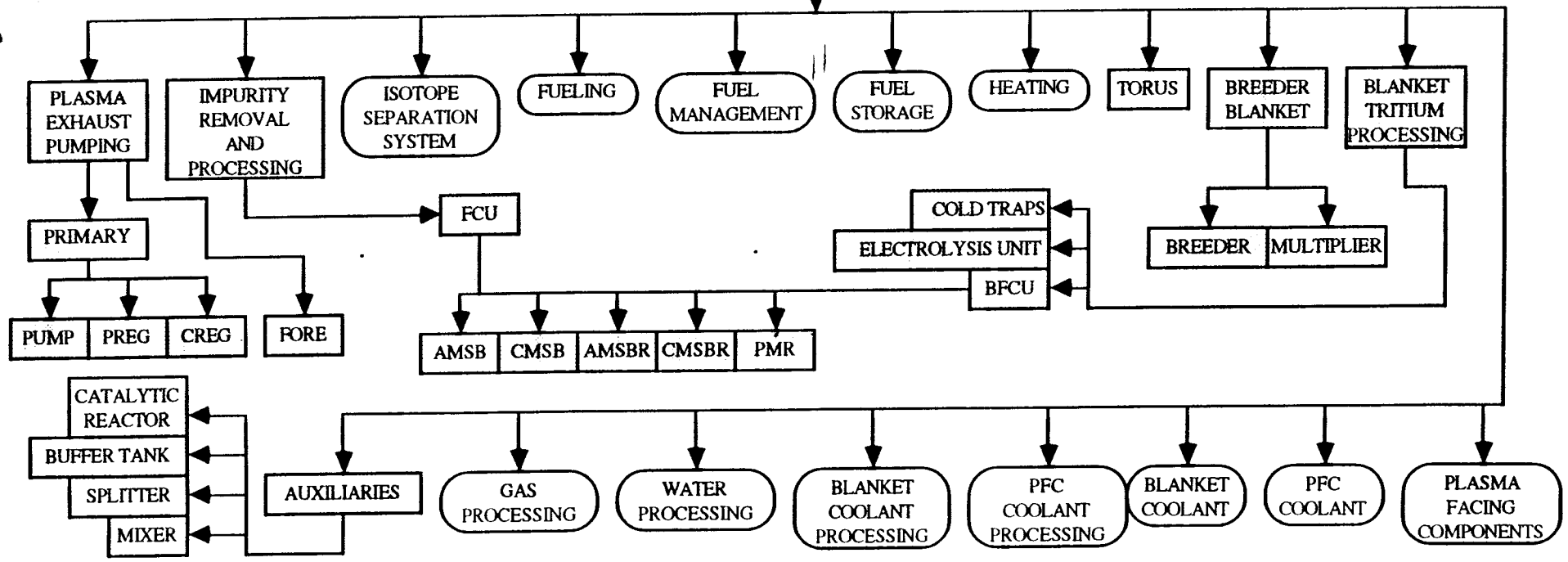

Summary

- We are in the process of getting US to take the lead on fuel cycle modeling which allows more economic exploration of an optimum ITER fuel cycle design and enhances ITER safety features.
- We are ready to commit ourselves to make this computer code available to JCT and all parties in a 2-year time frame.

Helium-Cooled Divertor for ITER

Techniques to Remove High Heat Fluxes with Helium

- ☆ High Re $Nu = 0.023 Re^{0.8} Pr^{0.4}$
 $Re \sim \rho v$
 - ☆ Improved Mixing roughened surface
ribs, tapes, helical vanes
 - ☆ Enhanced Surface Area fins
elongated channels
NFHX
-

In this talk...

- ❖ Parametric studies of “slotted duct” configuration
- ❖ 2-D thermal and structural analysis
- ❖ Assessment of NFHX under ITER conditions

Design Window

Primary design limits (approximate)

Maximum allowable Be temperature ~600°C (properties degrade)

Maximum allowable stresses in Be 100–150 MPa (tensile strength)
(thermal and pressure) in Cu 200 MPa

Maximum allowable coolant pressure 5–10 MPa leakage concerns

Maximum allowable coolant velocity ~200 m/s 1/3 sonic velocity,
vibration limit

“Temperature Budget”

$$T_{\max} = T_{\text{inlet}} + \Delta T_{\text{bulk}} + \Delta T_{\text{film}} + \Delta T_{\text{solid}} < 600^{\circ}\text{C}$$

$$\Delta T_{\text{solid}} = 5 \times 10^6 \text{ W/m}^2 * 5 \times 10^{-3} \text{ m} / 120 \text{ W/m-K} \sim 200^{\circ}\text{C}$$

$$T_{\text{inlet}} = 250^{\circ}\text{C} (?) \text{ (can we take some credit for film drop?)}$$

so...

$$\Delta T_{\text{bulk}} + \Delta T_{\text{film}} \sim 150^{\circ}\text{C}$$

Thermal-Hydraulic Goal

$$q = h \Delta T_{\text{film}} \rightarrow h > 50,000 \text{ is desired}$$

Design parameters assumed for example calculations

Armor material	Be	(100–120 W/m-K under irradiation)
Armor thickness	~5 mm	(hopefully can be reduced)
Substrate material	DS Copper	(~300 W/m-K unirradiated)
Maximum surface temp.	600°C	(mechanical properties degradation)
Minimum coolant temp.	150–250°C	(depends on credit for film drop)
Peak surface heat flux	5 MW/m ²	
Average surface heat flux	1–2 MW/m ²	
Heated path length	~2 m	

Heat Transfer in a Slotted Duct

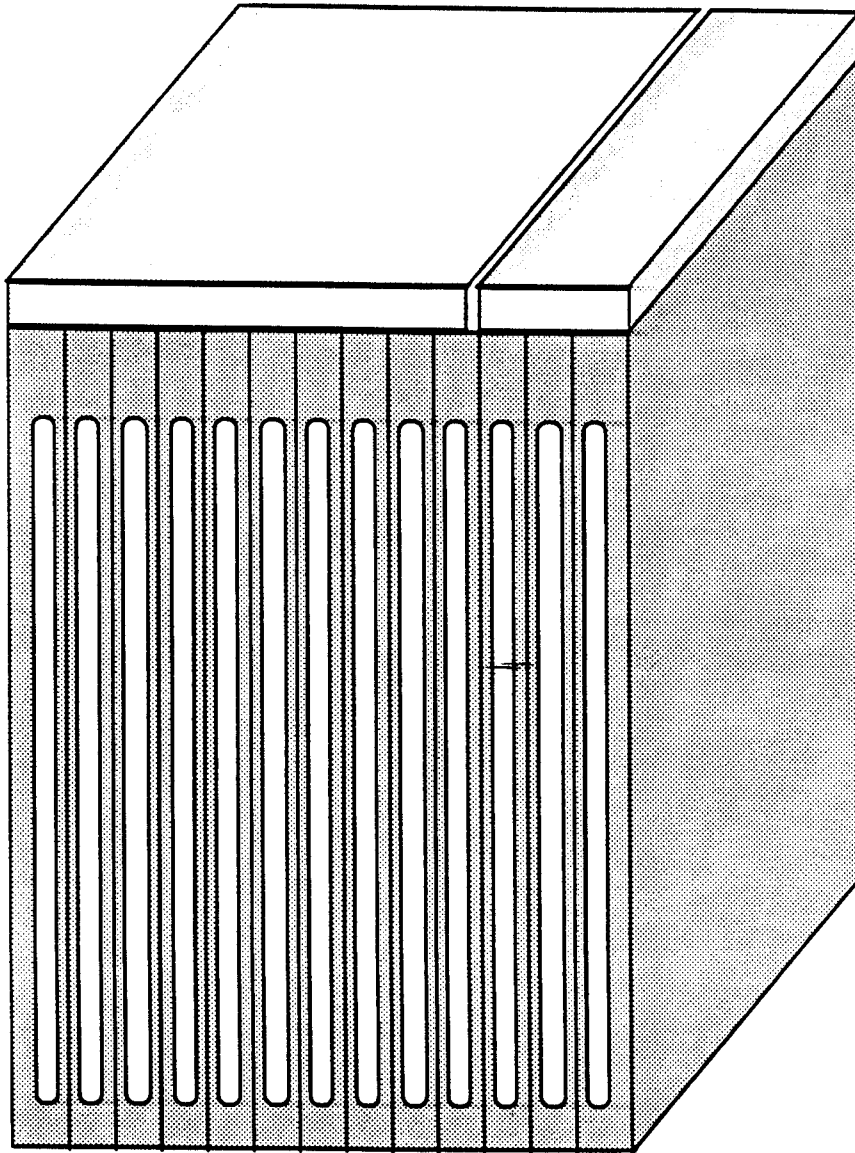

Analytic result:

$$\frac{h_{eq}}{h} \sim \frac{(a + \sqrt{2kt/h})}{a+t}$$

Heat Transfer Enhancement Factors

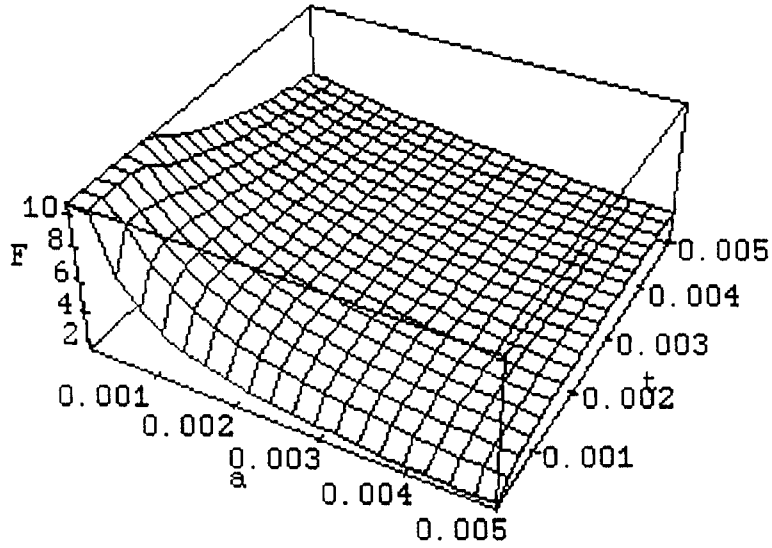

$\frac{h_w}{h}$ as a function of the channel height and wall thickness

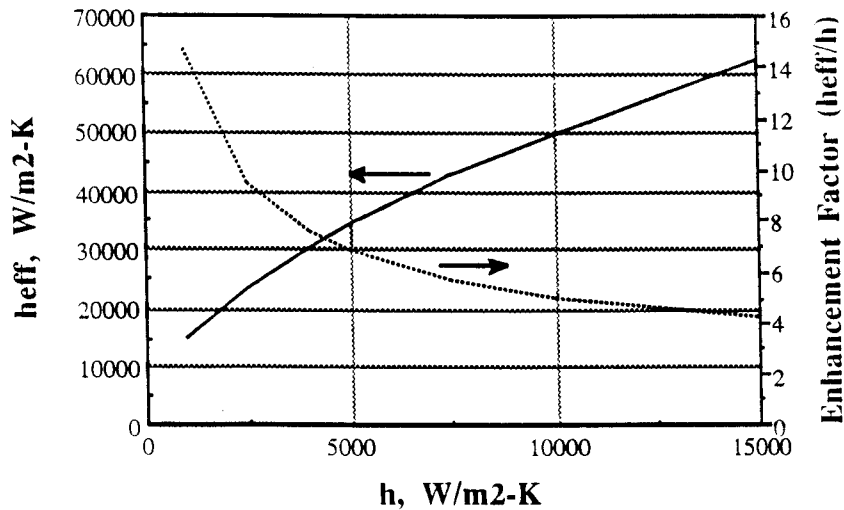

Effective heat transfer coefficient as a function of the coolant h

Two-Dimensional Results Confirm Analytic Predictions

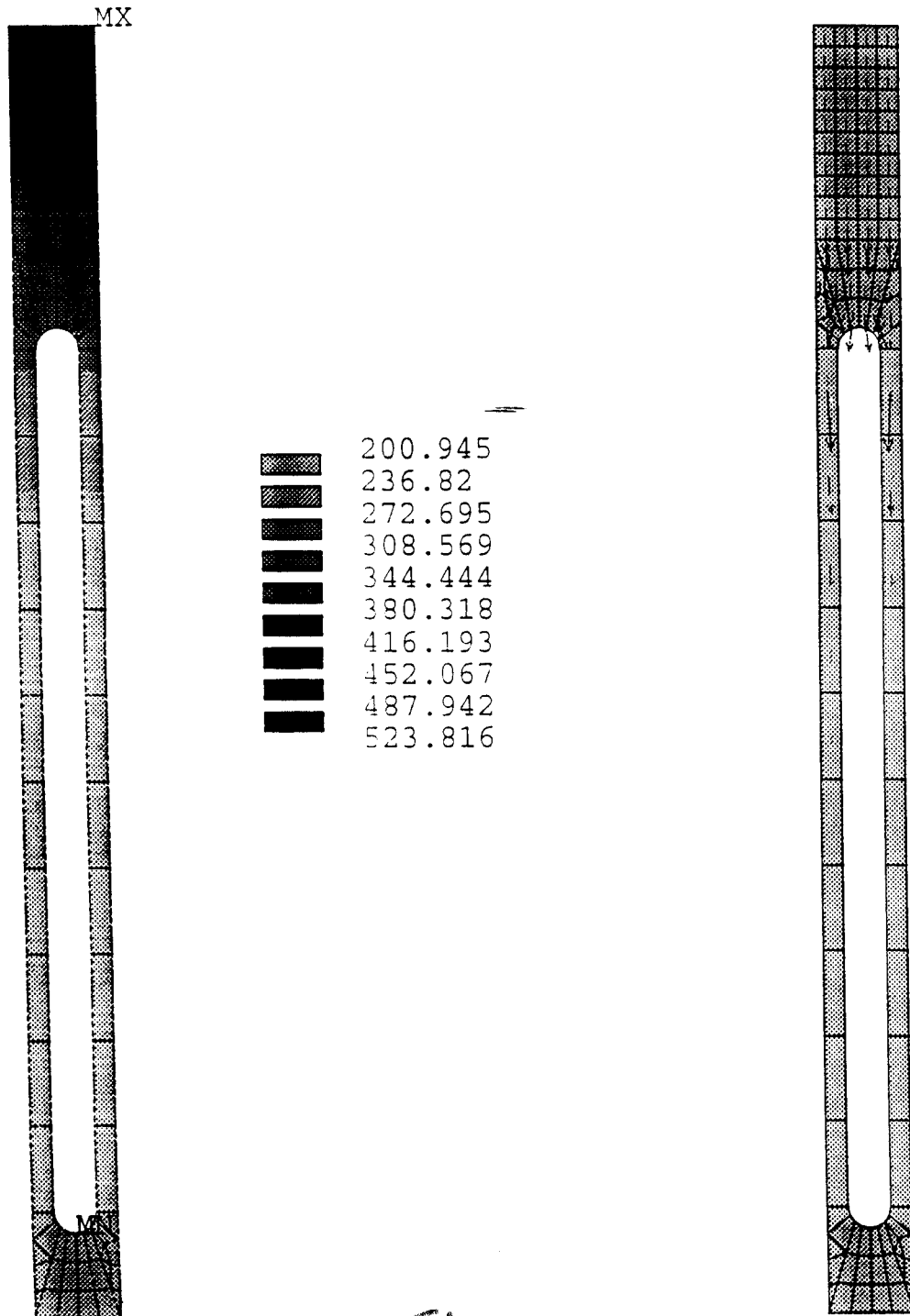

Stresses in Slotted Duct Design are Lower than in Circular Pipe Designs

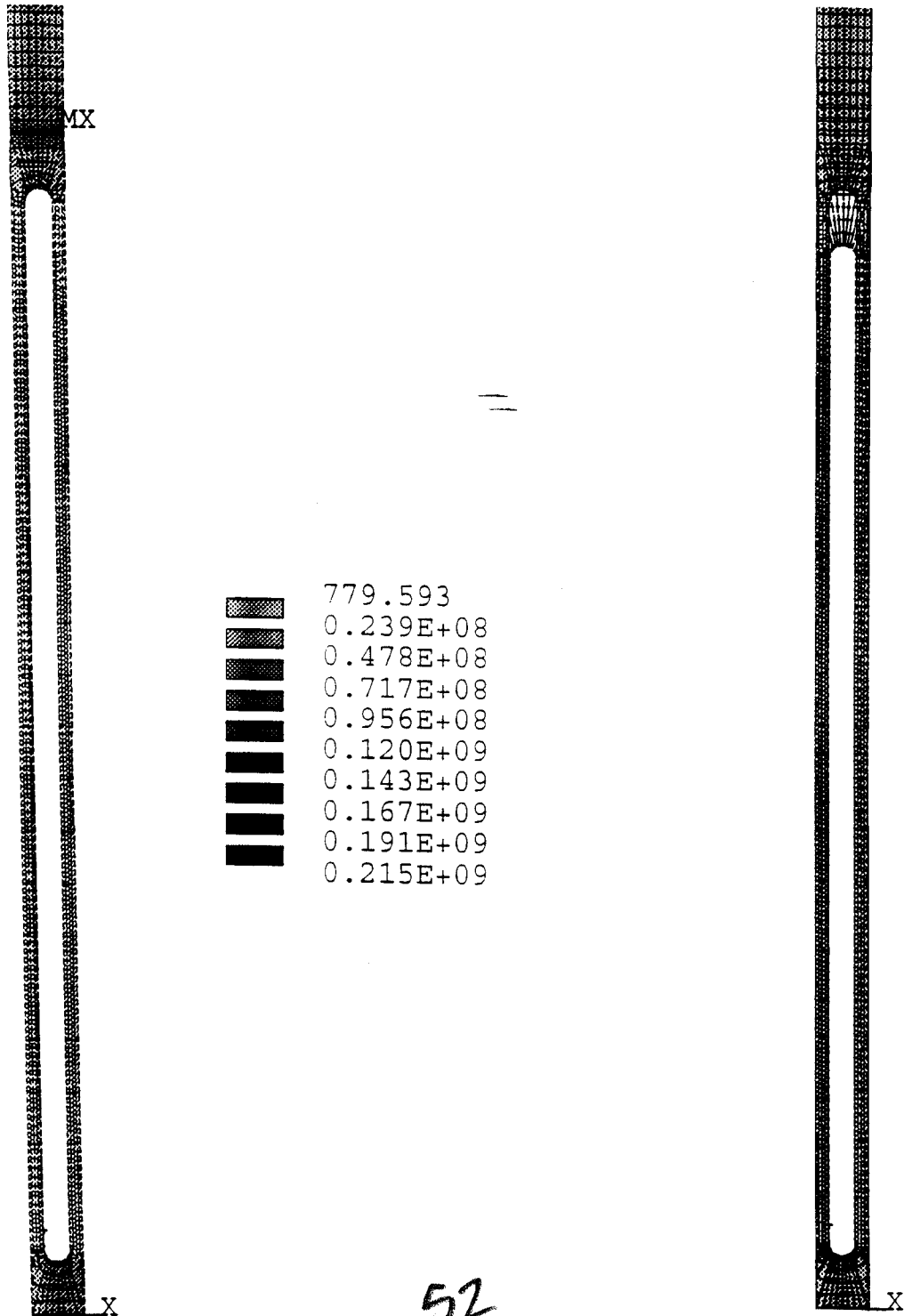

Structural Analysis in a Duplex Divertor

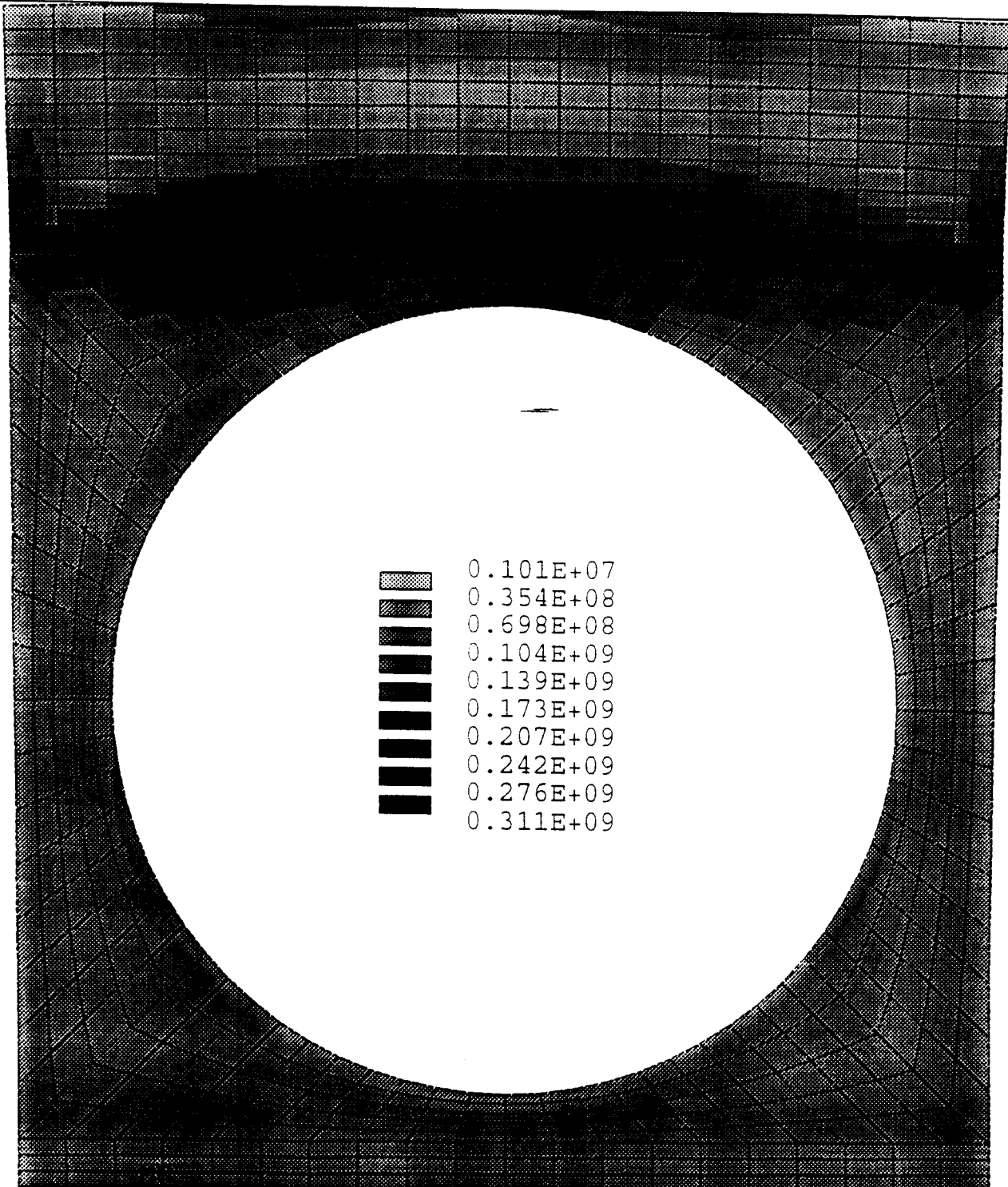

Structural Analysis in a "Monoblock" Divertor

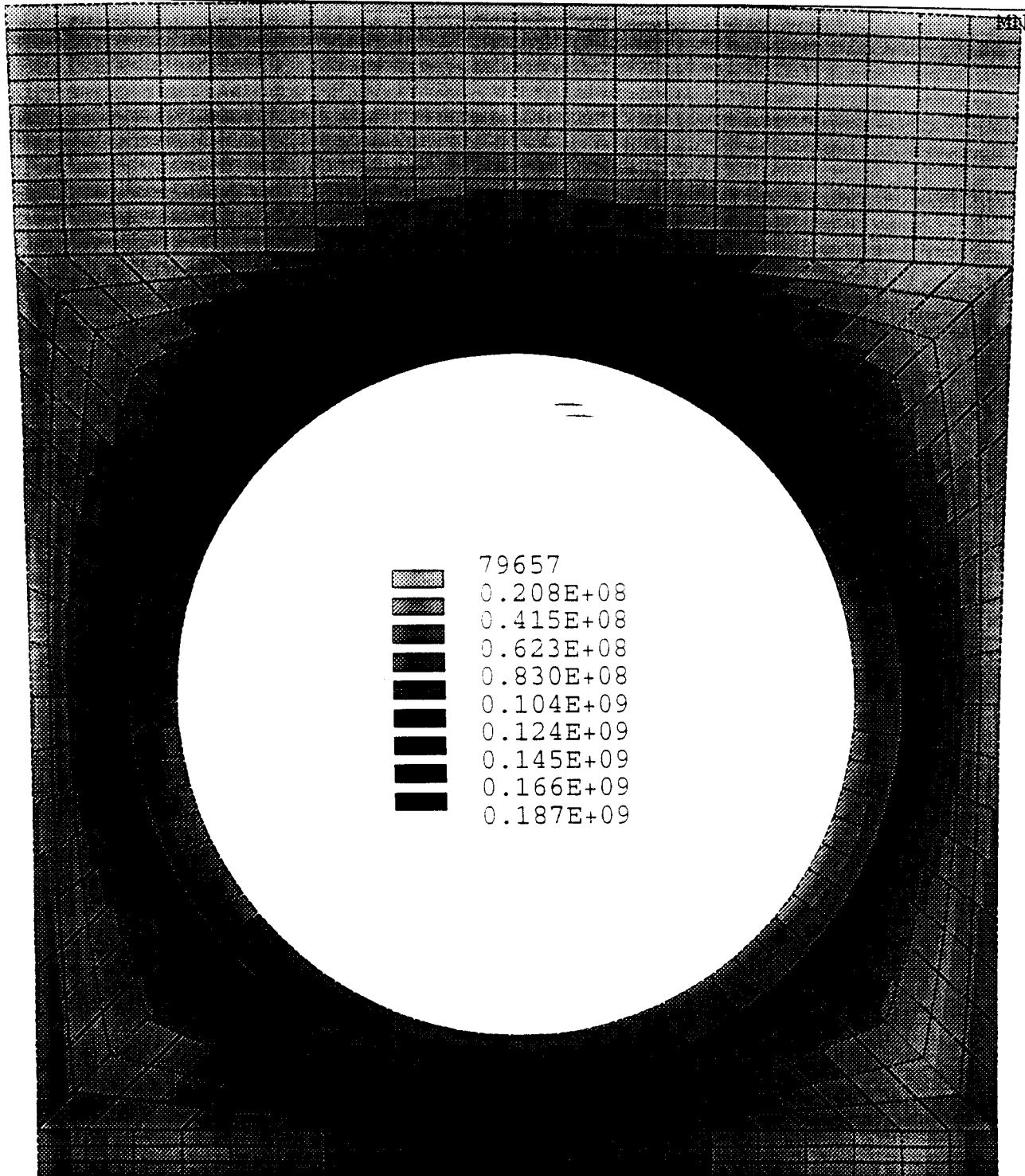

Normal Flow Heat Exchanger Design Concept (Creare, Inc.)

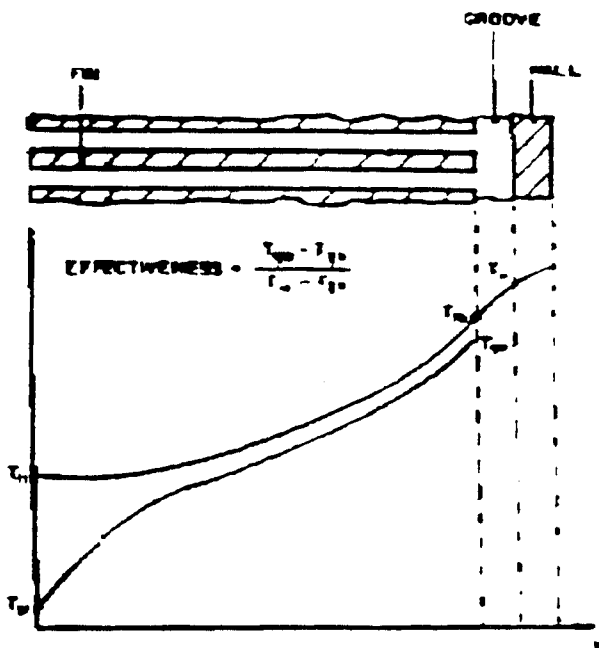
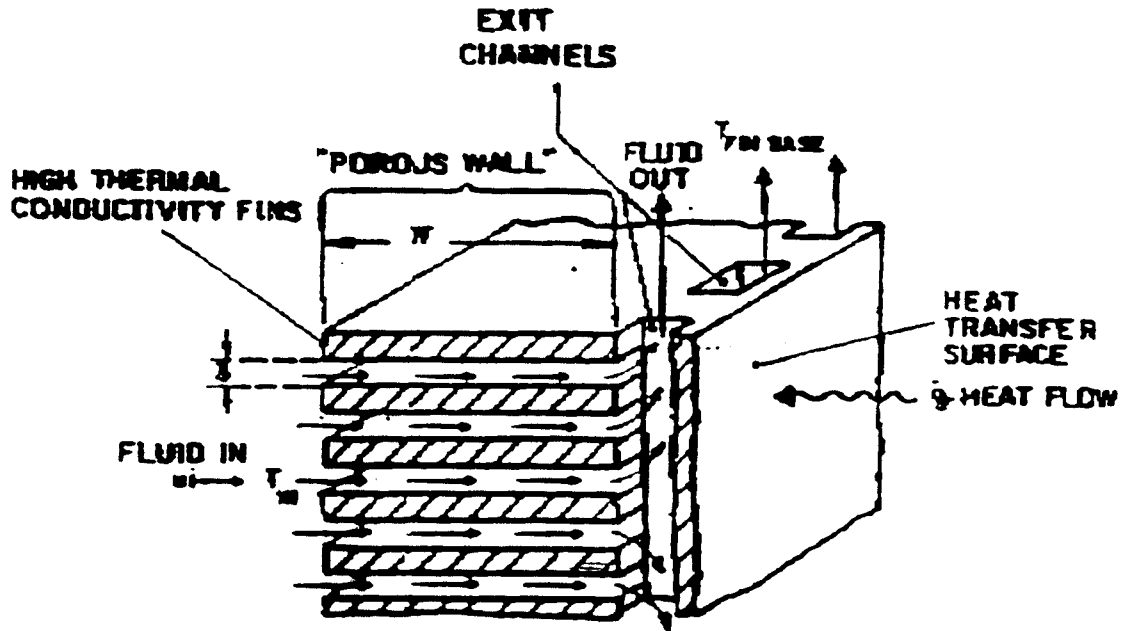

- low coolant velocity
- short flow path
- entire wall sees entire ΔT

Increased effectiveness with low mass flux and narrow channel spacing

Fabricated and Demonstrated to 8.5 MW/m^2

NFHX Parametric Study

Equations directly from Izenon ANS paper:

$$h = \varepsilon G c_p$$

G = superficial mass flux (mass flow/FW area)

$$\varepsilon = \frac{2}{1 + \sqrt{1 + C \Delta p^*}}$$

$$\Delta p^* = \frac{\Delta p}{G^2/2\rho}$$

$$C = \frac{G^3 c_p^2 \delta^4}{48 k_f k_g (1-R) \mu W}$$

Results:

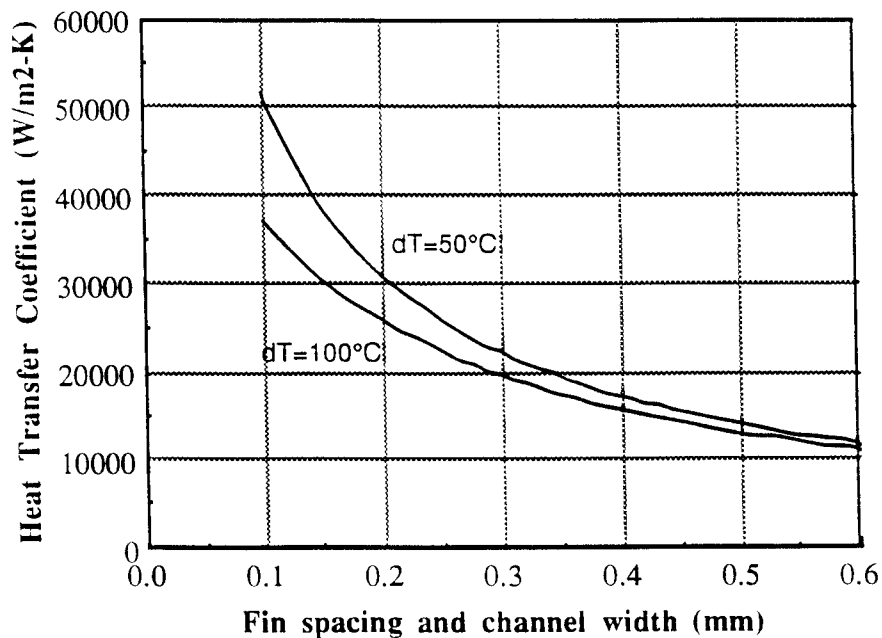

NFHX Performance Under ITER Constraints

NFHX fin effectiveness vs fin spacings for different coolant temperature rises
(NFHX design parameters see Izenson's paper)

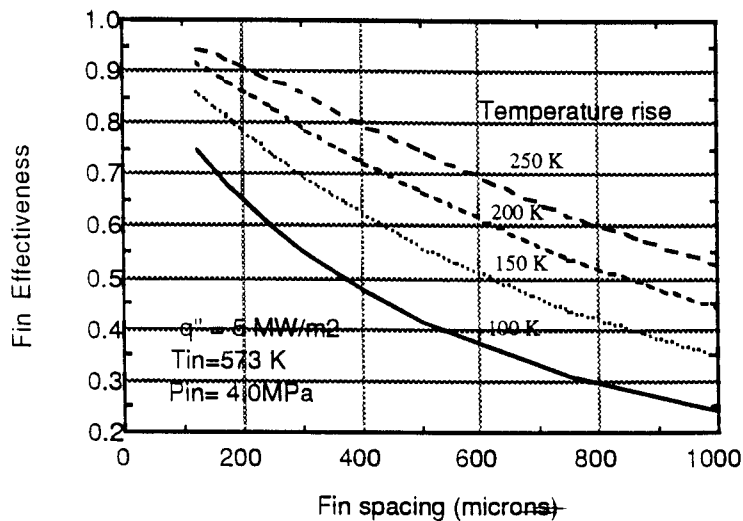

**NFHX performance summary for 5 MW/m² ITER surface heat load
(Helium inlet temperature: 573 K, Helium pressure: 4 MPa)**

Coolant Temperature Rise (K)	Fin Effectiveness	Fin Spacing (microns)	Pressure Drop (Pa)	Maximum Wall Temperature °K, (no Be)
100	0.727	140	6451	796
150	0.84	145	4430	837
200	0.88	175	2169	886
250	0.9	200	1326	936.5

Conclusions

- * **He cooling can provide adequate heat removal**
 - up to 5 MW/m² peak and 2 MW/m² average surface heating
 - with modest pressure (5 MPa or lower)
 - $h \sim 50,000 \rightarrow \Delta T_{\text{film}} \sim 100^\circ\text{C}$
 - $\Delta T_{\text{bulk}} \sim 75^\circ\text{C}$

- * **The slotted duct configuration is attractive and should be further investigated**
 - reasonable stresses (except $\bar{\sigma}$ at joint)
 - modest pumping power
 - @100 m/s, 2-m channel, $\Delta p \sim 1$ atm
 - 84 kW/m², or ~ 17 MW total (200 m² divertor)
 - several possible fabrication techniques

- * **Limits imposed by the use of Be, including high thermal stresses may become dominant constraints on the design window if the conditions above are achieved**

Solid Breeder Blanket Thermal Control

Experiments and Modeling

Thermal Control Issue for Solid Breeder Blankets

- Maintain breeder within allowable temperature limits
 - uncertainties due to manufacturing and operating conditions
 - accommodate power variations
 - correct for radiation-induced changes in behavior
 - Generic issue for blankets
 - Critical issue for ITER
 - Breeding Blanket
 - Test Modules
 - DEMO and commercial power reactors
-

Goals of UCLA Program

- Develop innovative design solutions to thermal control problem
e.g., **active control mechanisms**
 - Develop modeling capability to accurately predict blanket behavior
 - Generate empirical data used for design
 - Validate concepts through experiments and modeling
-

Thermal Control Group Activities at UCLA

Particle Bed Heat Transfer Experiments and Modeling

- Packing experiments
- Effective thermal conductivity
- Wall conductance
- Purge flow characteristics

Contact Resistance Between Metal Surfaces (sintered Be and steel)

- Studies of effect of surface conditions, contact pressure, thermal deformations, background gas pressure and composition

Mechanical Interactions in Pebble Beds

- Effective coefficient of thermal expansion
- Effect of internal (thermal) expansion on k_{eff} and h
- Effect of external pressure/deformation on k_{eff} and h

Unit Cell Experiments

Geometrical elements of solid breeder blankets

Interactions between thermal & mechanical behavior, neighboring elements

Thermal Control Experiments at UCLA



<i>Basic Properties</i>	<i>Separate Effects</i>	<i>Multiple Effects</i>	<i>Partially Integrated</i>
<p>PBX (<i>operational</i>)</p> <p>Pebble Bed Heat Transfer at Low Temperature</p> <p>Gas Phase Control</p> <p>Effective Bulk Conductivity</p> <p>Wall Conductance</p> <p>Pressure Drop</p>	<p>HiTeC (<i>in planning</i>)</p> <p>High Temperature Cyclic Heat Transfer in Prototypic Geometry</p> <p>Be or Ceramic Pebble Beds</p> <p>Independent Control of Temperature and Gradient</p> <p>Bulk Conductivity</p> <p>Wall Conductance</p> <p>Effect of Bed or Clad Deformations</p>	<p>UNICEX (<i>under construction</i>)</p> <p>Solid Breeder Blanket Unit Cell</p> <p>Thermomechanical Interactions</p> <p>Breeder & Multiplier at Prototypic Conditions</p> <p>Simulation of Bulk Heating</p> <p>He or Water Coolant, He purge</p>	
<p>ICE (<i>operational</i>)</p> <p>Interface Conductance</p> <p>Be With Surface Roughness</p> <p>High Contact Pressure</p> <p>Variable Heat Flux</p> <p>Control of Gas Phase</p>			
<p>HTBX (<i>operational</i>)</p> <p>Pebble Bed Heat Transfer at High Temperature</p> <p>Mechanical Response to Thermal Expansion</p> <p>Effect of Mechanical Constraints on Heat Transfer</p>			

62

Thermo-Mechanics Modeling at UCLA



Packed Bed Effective Thermal Conductivity

- 2-D model developed and calibrated; with extensive capabilities, (Gas pressure variation, high ks/kg, single-size and binary bed, porosity, contact area, roughness)
- Several simple, faster-to-run models based on the literature have also been coded: (modified Hall&Martin, Bauer&Schlunder, Kunii&Smith)

Packed Bed Wall Conductance

- Model developed and calibrated; provides lower and upper bound estimates based on porosity distribution at the wall and
- Simple lower-bound expression proposed for initial design calculations

• Help in the understanding of thermomechanics behavior of ceramic breeders and Be in packed bed and sintered block forms.

• Provide tools for analysis of blanket performance under different conditions and for determination of thermal controllability of ceramic breeder blanket.

• Help determine range of blanket parameters and conditions over which uncertainties in the blanket performance are highest. The results can then be used to recommend most needed experiments.

• Provide tools for pre- and post- analyses of blanket partially -integrated and integrated experiments.

• Share modeling results with national and international organizations

Contact Conductance

- Models based on Shlykov and Yovanovich have been coded
- Plan is to develop a semi-empirical model for Be/SS based on these models and our experimental results

Porous Flow

- Steady-state model based on modified Darcy's equation has been developed/ Velocity profile, Pressure drop
- Transient capability is being developed/ LOFA analysis

Summary of Recent UCLA Accomplishments in Solid Breeder Thermomechanics

New Be data in PBX

First data in ICE

- Initial steel/steel data
- Experimentation with surface preparation techniques
- Test apparatus modified for mechanical measurements

Library of modeling tools is in place to analyze a wide range of problems using different levels of approximation

- Applied to design studies
- Applied to experimental comparisons
- 3-D analysis capability is now in place

Design of unit cell test article completed using engineering scaling

- First detailed application of engineering scaling on an actual experiment
- Design review meeting held July 6 with wide community involvement

Development of heater technology

- Thin, high-power, high-temperature, structurally-integrated heaters for out-of-pile testing

Major investment in facilities and capabilities

- Breeder and multiplier materials
 - Facility modifications
 - Computer data acquisition system
 - Workstation for 3-D analysis
-

Metallic Particle Bed Experiments

1. Thermal Conductivity

Effective thermal conductivity was measured:

- for a range of He and N₂ gas pressures
- for several single-size and binary Al beds
 - different particle sizes
 - different surface roughnesses
- for a range of porosities
- reproducibly in 2 different test sections

CS
The effective thermal conductivity of metallic packed beds shows substantial variation with gas pressure (and composition) – in some cases as much as a factor of 4. This clearly demonstrates the possibility of active temperature control in solid breeder blankets.

- Data was provided to the U.S. ITER team, to CFFTP, JAERI, and in several national and international meetings, including ISFNT-2.
- JAERI has initiated studies of active control for application in their ITER blanket design.

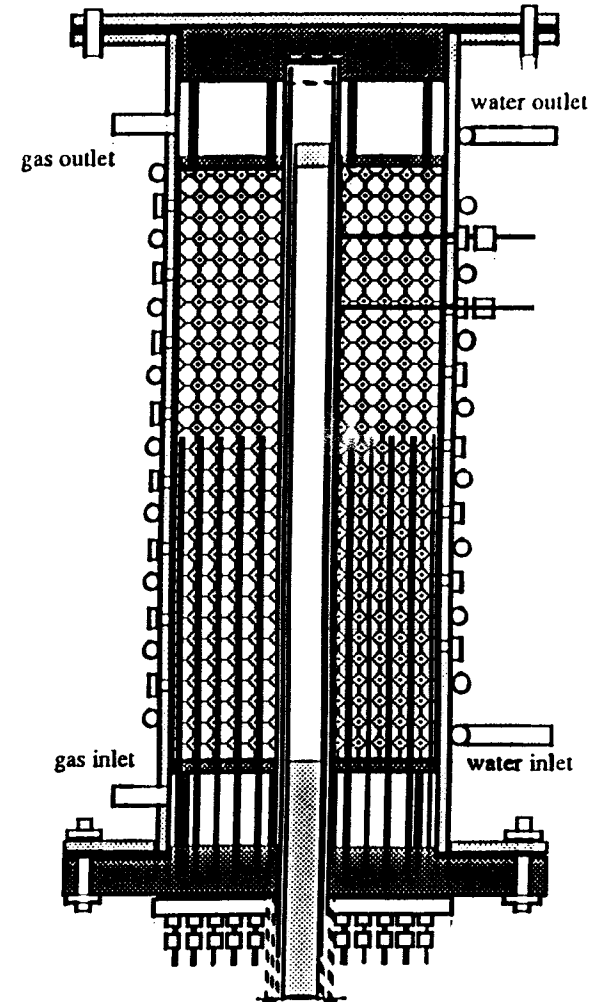

New Data in Be Confirms Previous Measurements in Al

2-mm Be spheres, 60% packing, 2 μm average roughness

Keff vs. Pressure for Be Bed with He, Air, and Nitrogen

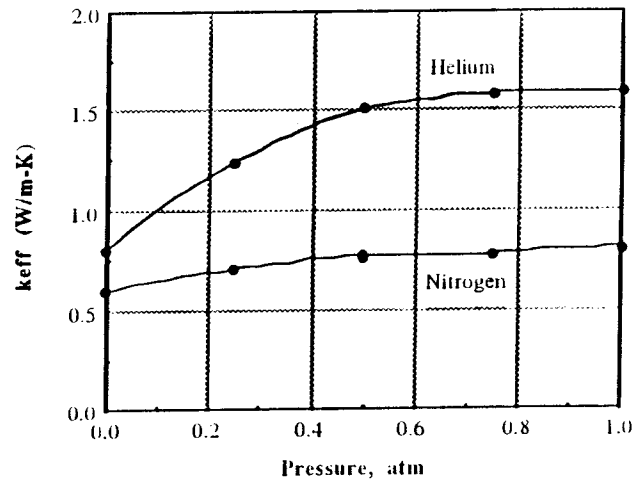

Effective Thermal Conductivity of Be with 1 atm of He/air Mixture

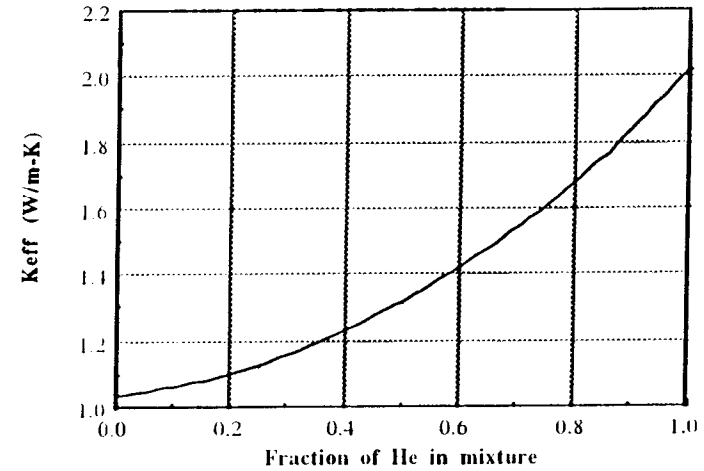

- Both gas pressure and composition are effective controls for the bed effective thermal conductivity
- Results are consistent with model predictions and simulations in Al

Parametric Modelling Studies Provide Important Insight into Physical Processes

67

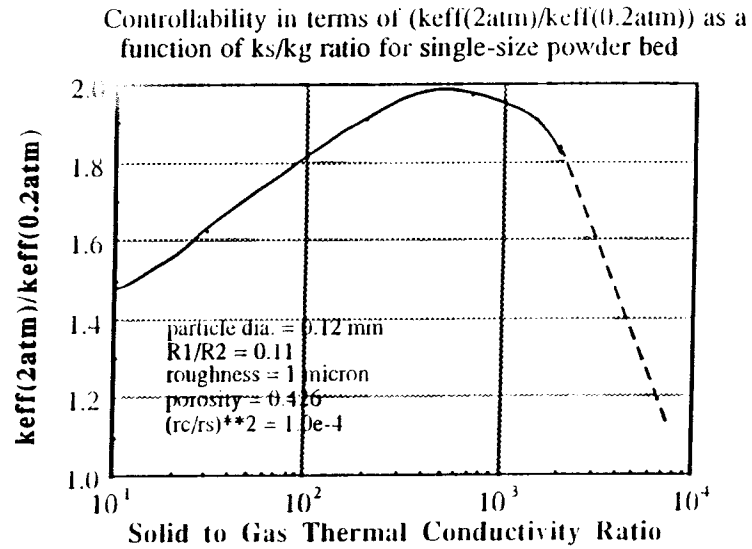

Optimum Control is Obtained at $k_s/k_g \sim 500-1000$

- Al/He $k_s/k_g \sim 1200$
- Be/He $k_s/k_g \sim 600$

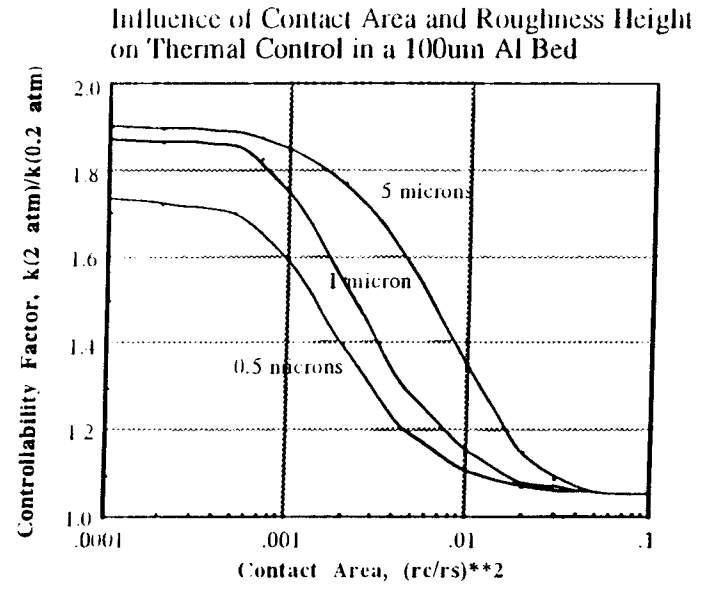

Better Control is Obtained with Low Contact Area and Rougher Surfaces

Sintered Block Interface Conductance Experiments

Motivation

- Changes at interfaces due to environmental factors (thermal gradients, mechanical stresses, radiation effects, etc.) could result in significant degradation of the normally high interface conductance in some solid breeder blanket designs
- Need experiments
 - Discrepancies in model predictions
 - Specific material properties are important in this case
- US ITER blanket design adopted sintered Be blocks – request for data was made by US ITER design team

Objectives

- Measure the thermal conductance at interfaces between sintered blocks of multiplier, clad, and possibly breeder
- Examine the effect of environmental factors and assess the possible implications for the use of sintered Be and breeder in ITER
- Use data for model validation

Operating Parameter Ranges for the Interface Conductance Experiments

- The temperature jump at the interface will be measured as a function of the contact pressure, surface roughness, cover gas pressure, and heat flux
- Using prototypical temperature gradients, heat fluxes, and contact pressures

004

Contact conductance	h	$200 \leq h \leq 20,000 \text{ W/m}^2\text{-K}$
Heat flux	q	$5 \sim 20 \text{ W/cm}^2$
Surface roughness	δ	$10 \leq \delta \leq 50 \mu$
Cover gas composition		N_2, He
Cover gas pressure	p	$10^{-4} \text{ Torr} \leq p \leq 3 \text{ atm}$
Contact pressure	P_c	$0 \sim 50 \text{ MPa}$

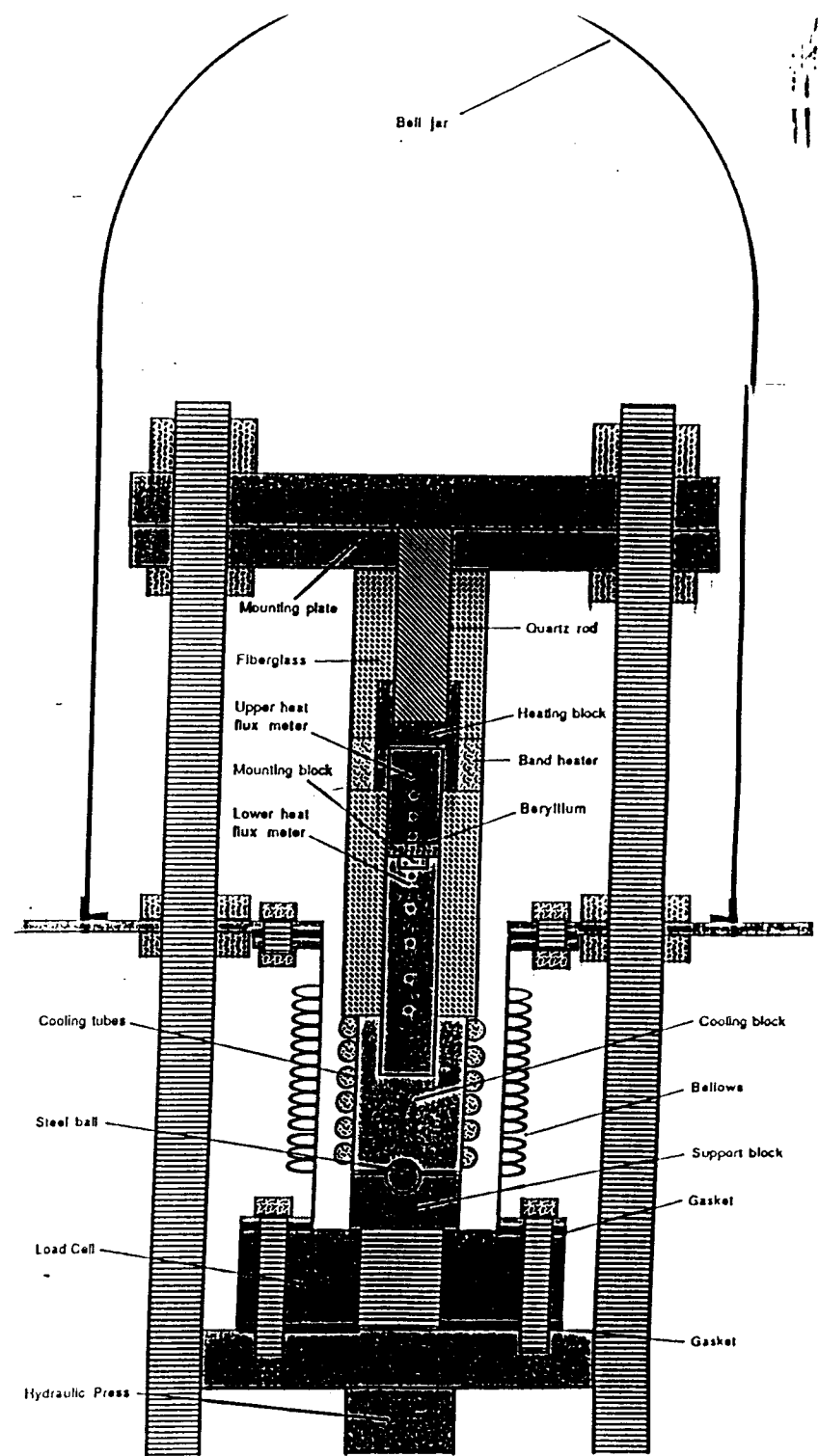

Comparison of our 304 SS data with Song data and Yovanovich model

OK

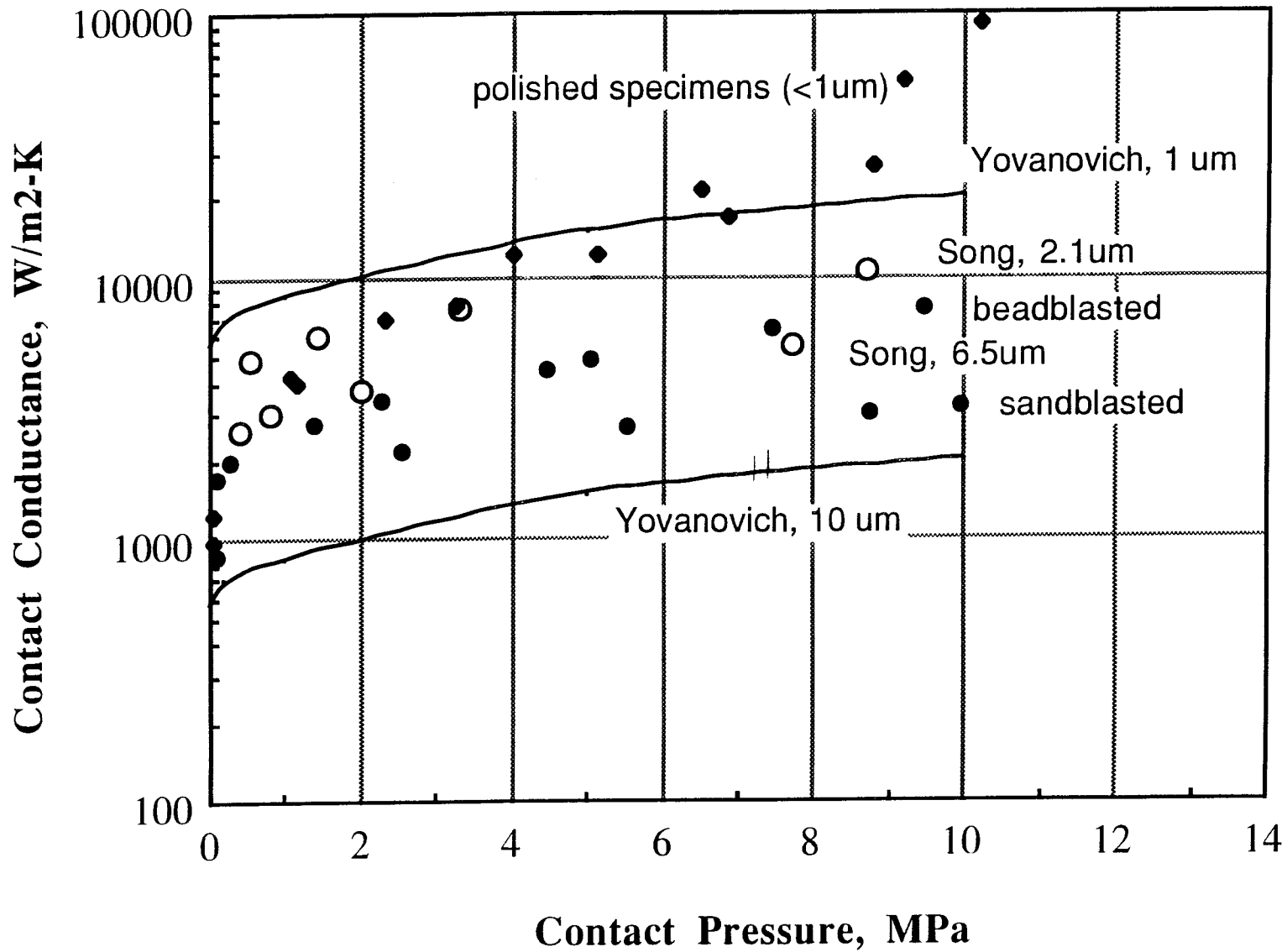

The Contact Conductance at Interfaces Depends on Several Variables

Steel Data (Song & Yovanovich)

Steel Model (Shlykov)

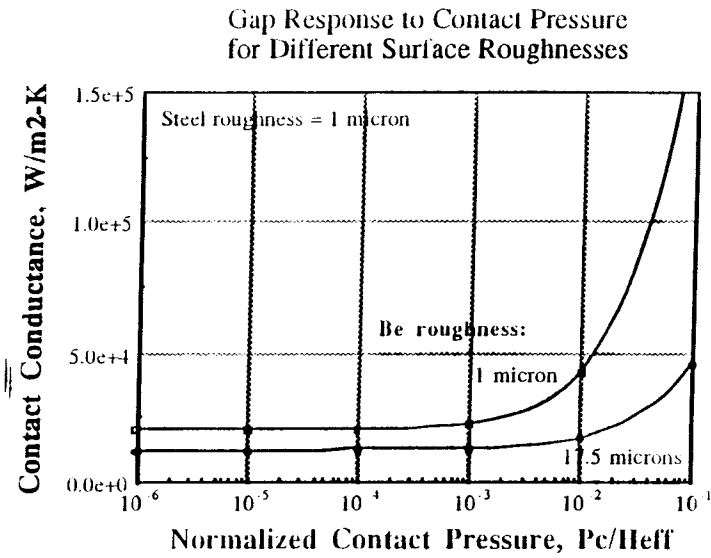
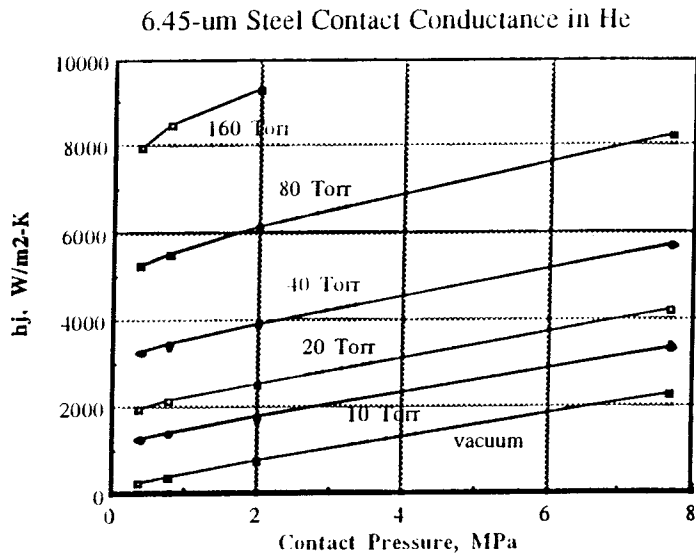

- Active control is possible over a limited range of parameters
- Rougher surfaces have lower h_c , but a larger stable range of operation

High Temperature Bed Thermomechanics



OBJECTIVES:

TO QUANTIFY THE VARIATIONS IN THE PARTICLE BED THERMAL PROPERTIES
(EFFECTIVE BED THERMAL CONDUCTIVITY AND BED/CLAD INTERFACE
CONDUCTANCE COEFFICIENT) WITH THE APPLIED EXTERNAL LOAD

TO GENERATE A DATA BASE TO HELP THE DESIGN AND ANALYSIS OF THE MORE
COMPLEX AND INTEGRATED THERMOMECHANICAL TESTS AND THE DESIGN OF
BLANKETS BASED ON STATIONARY PARTICLE BED CONCEPT.

73

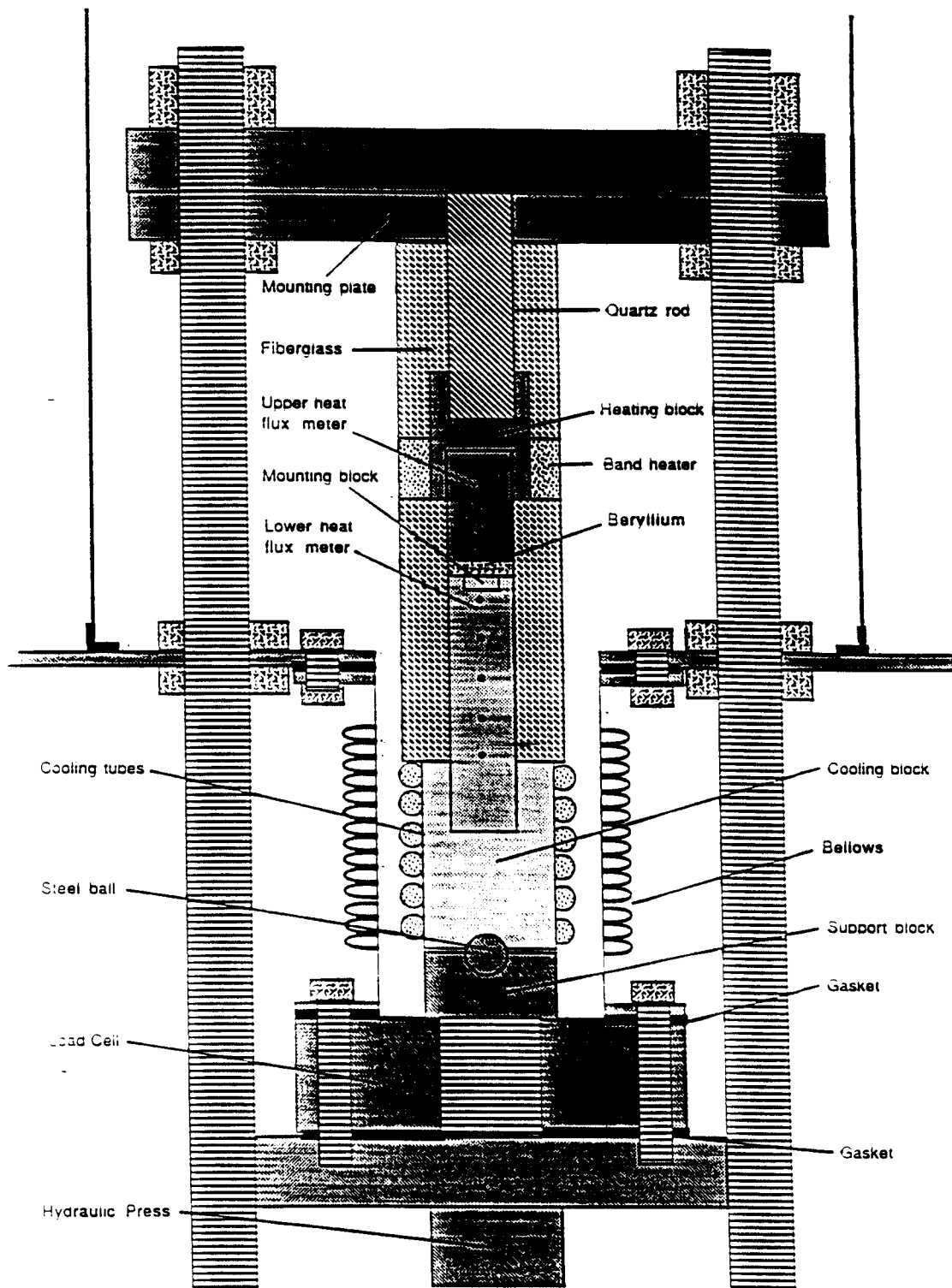

Figure 1. Experimental Set-Up

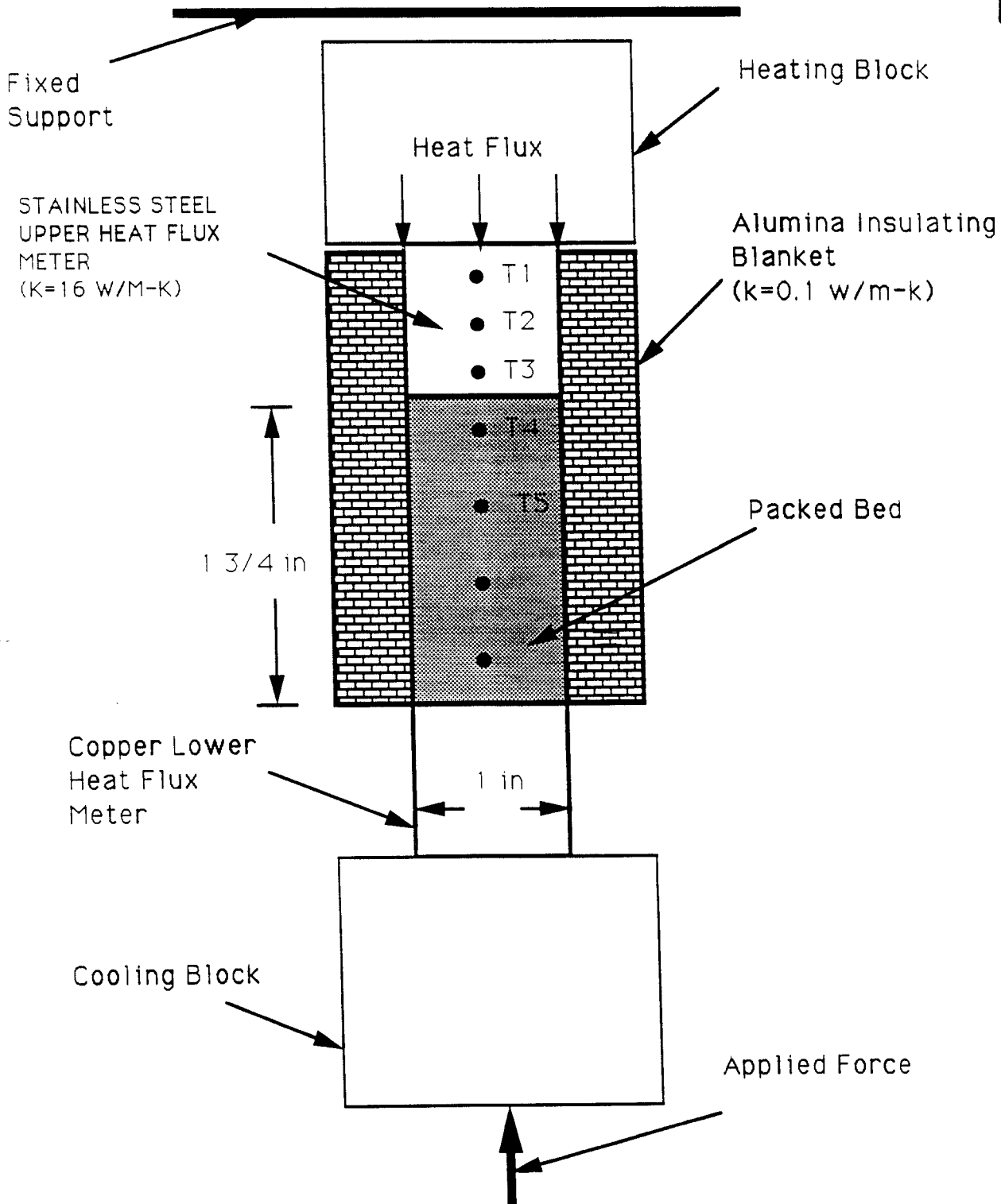

Figure 2. Test Article General Configuration

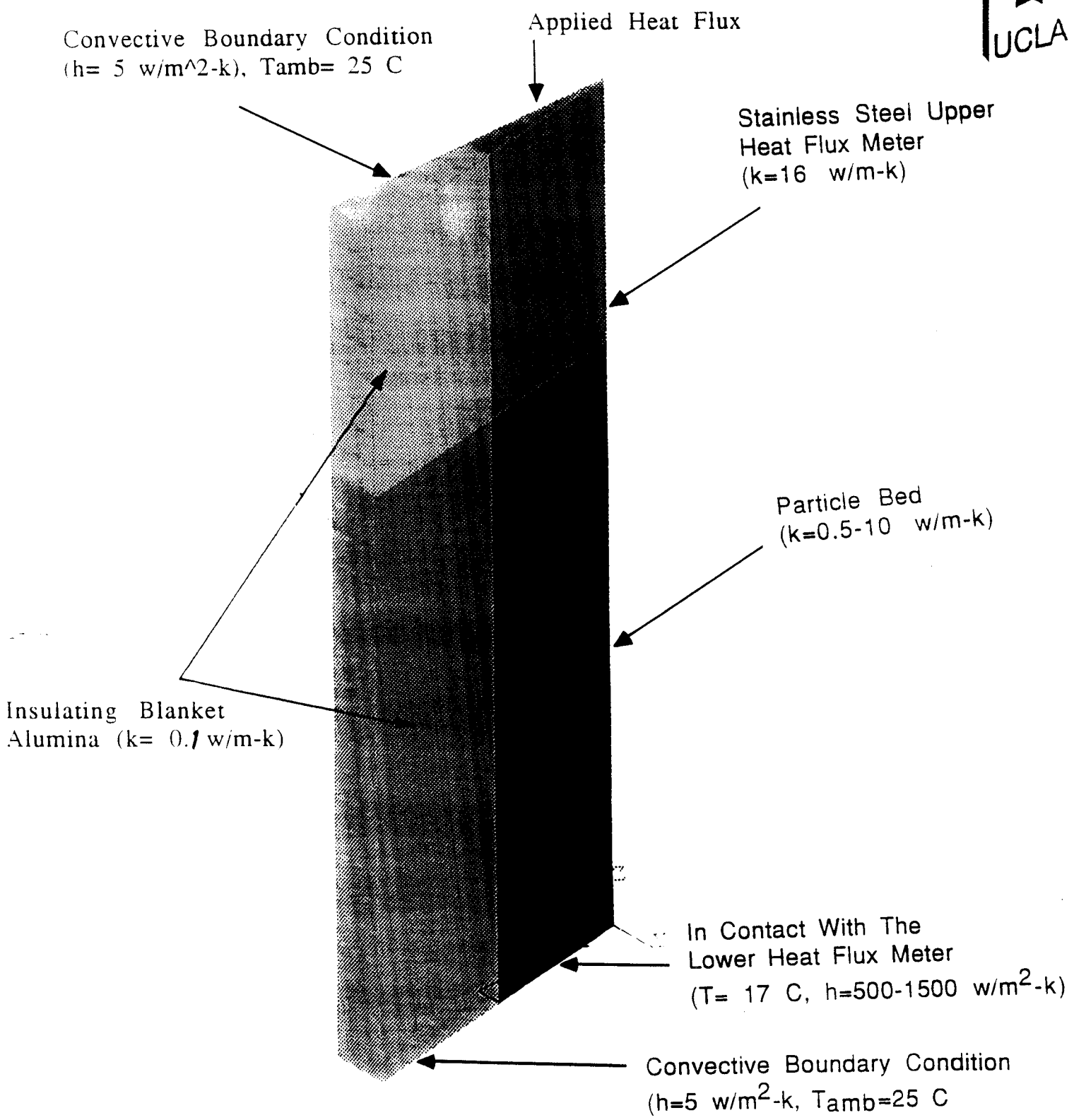

Figure 6. Thermal Model of The test Article (Particle Bed, Upper Heat Flux Meter and The Insulating Blanket)

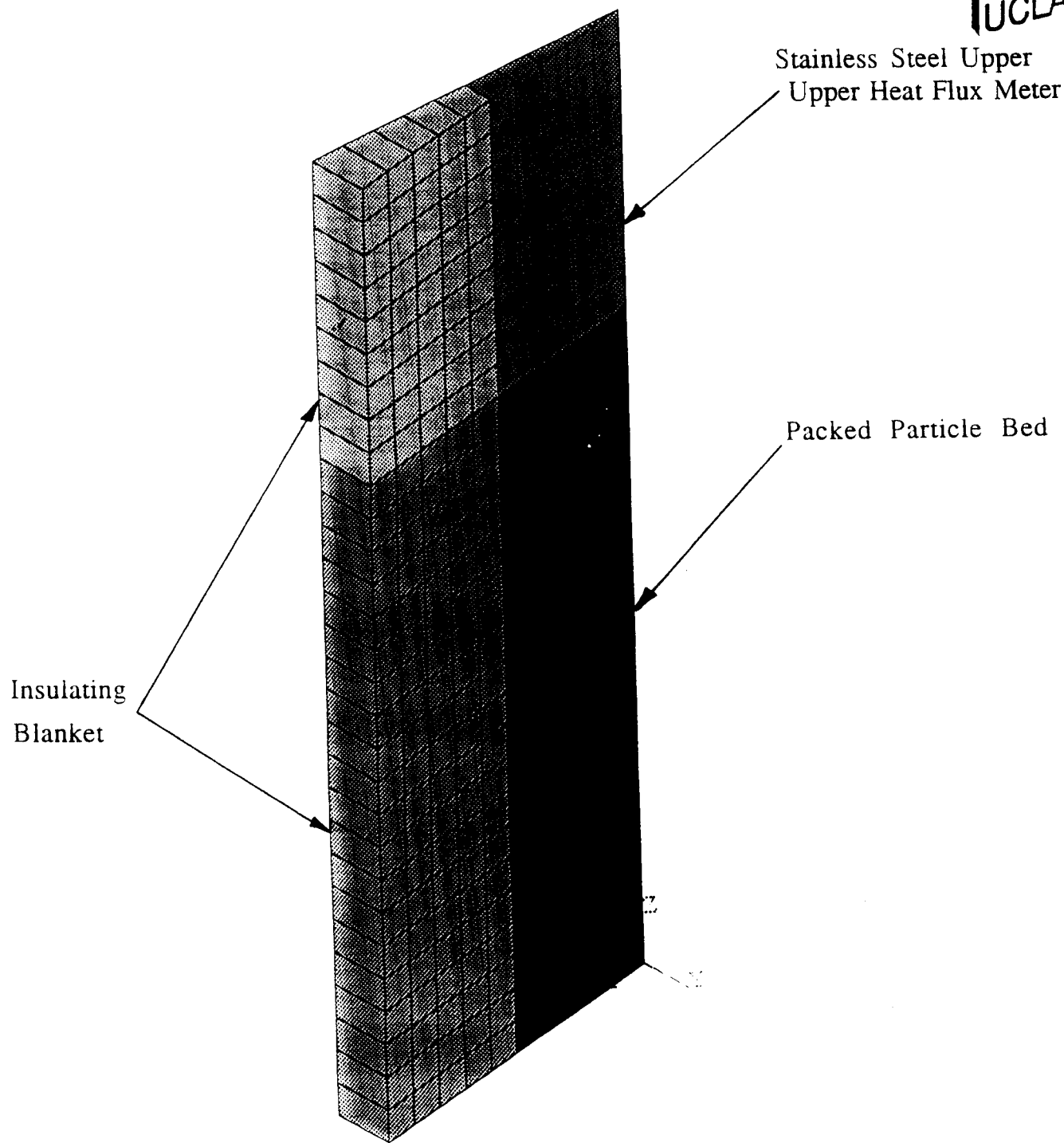
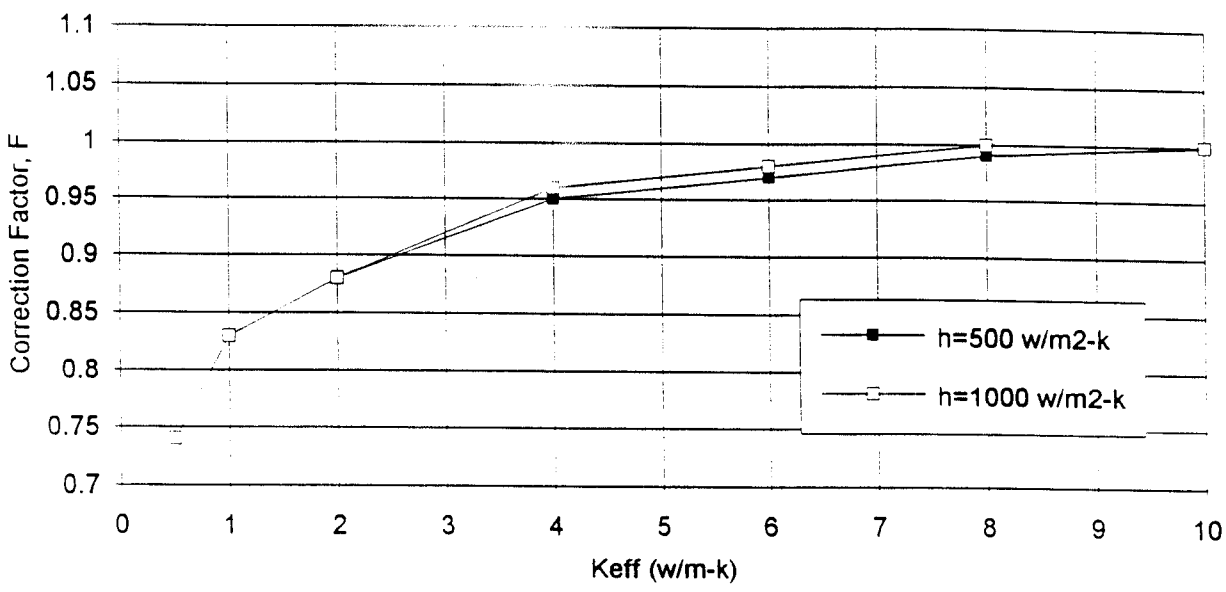

Figure 7. Ansys Finite Element Meshing of The Test Article
(290 elements)



Figure 11. Fractional Heat Loss Between Thermocouple positions T4 and T5



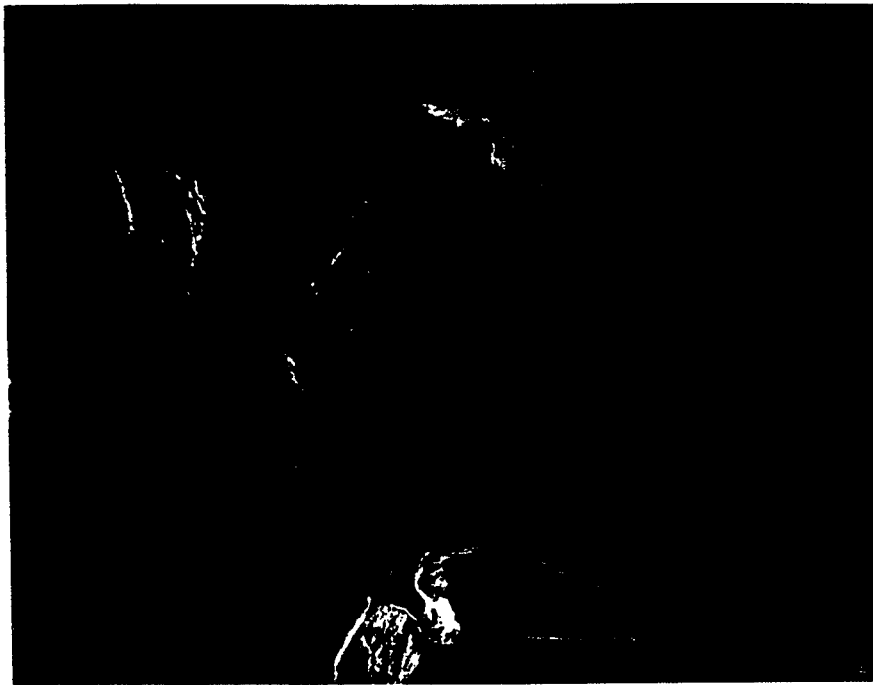

Figure 3. Scanning Electron Micrograph of The Lithium Zirconate Particles

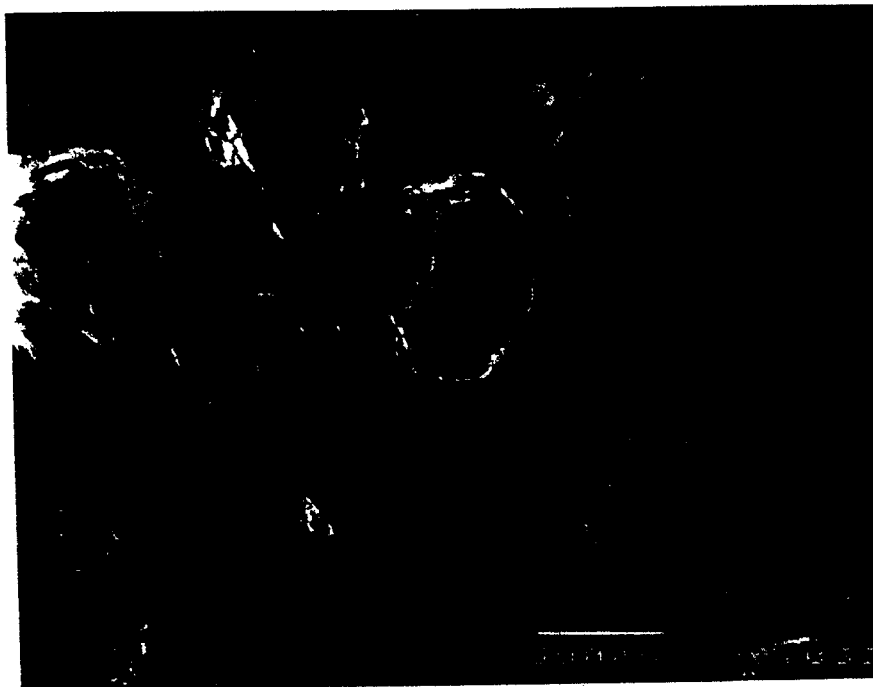
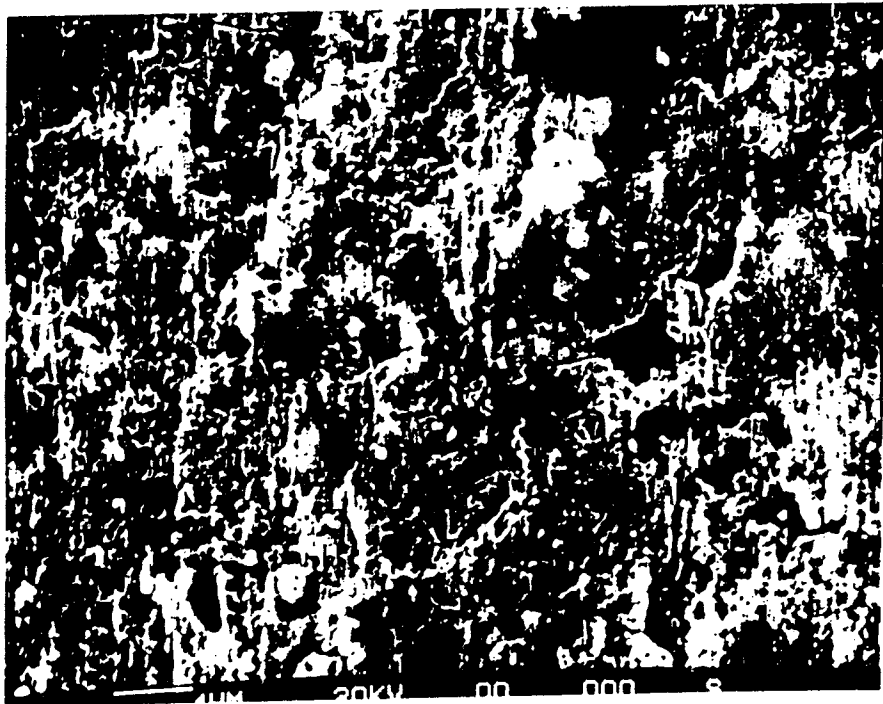

Figure 4. Scanning Electron Micrograph of The Aluminum Particles



4 μm

80

Figure 5. Scanning Electron Micrograph of The Beryllium Particles

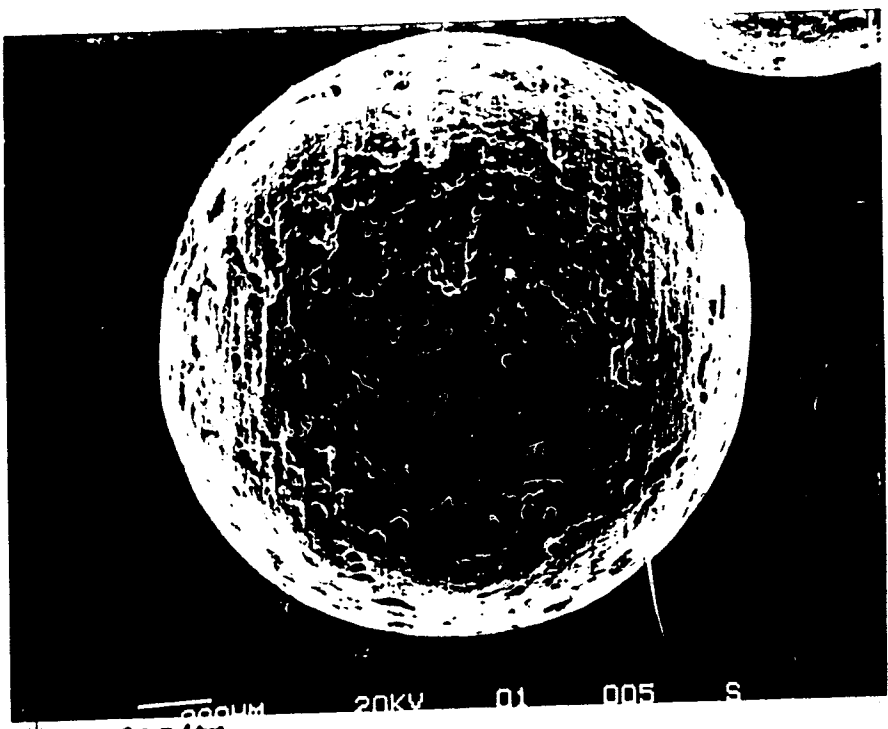

200 μm

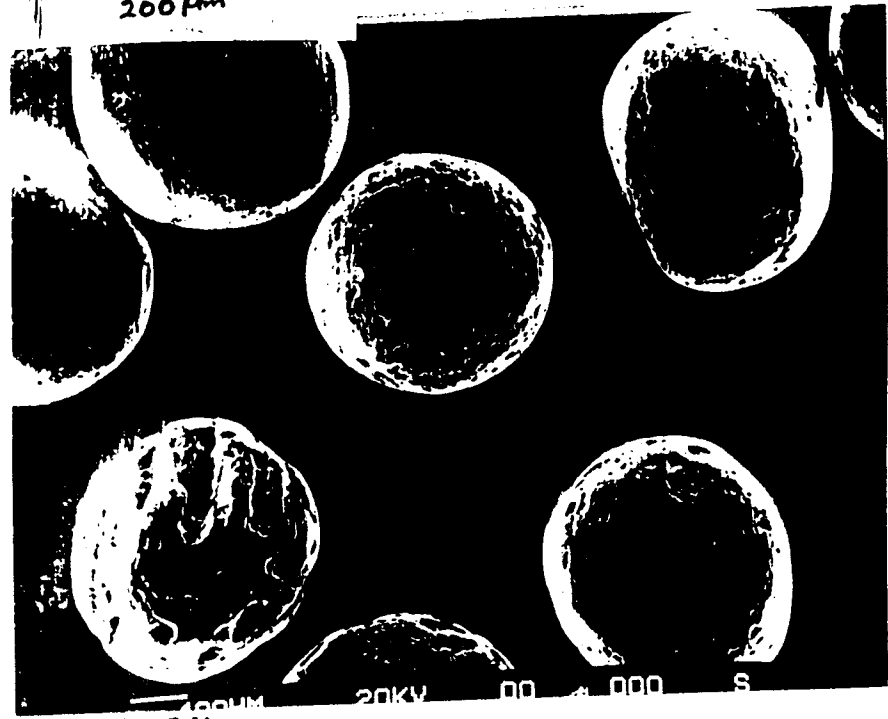

400 μm

EFFECT OF EXTERNAL LOAD ON ALUMINUM PARTICLE BED EFFECTIVE THERMAL CONDUCTIVITY

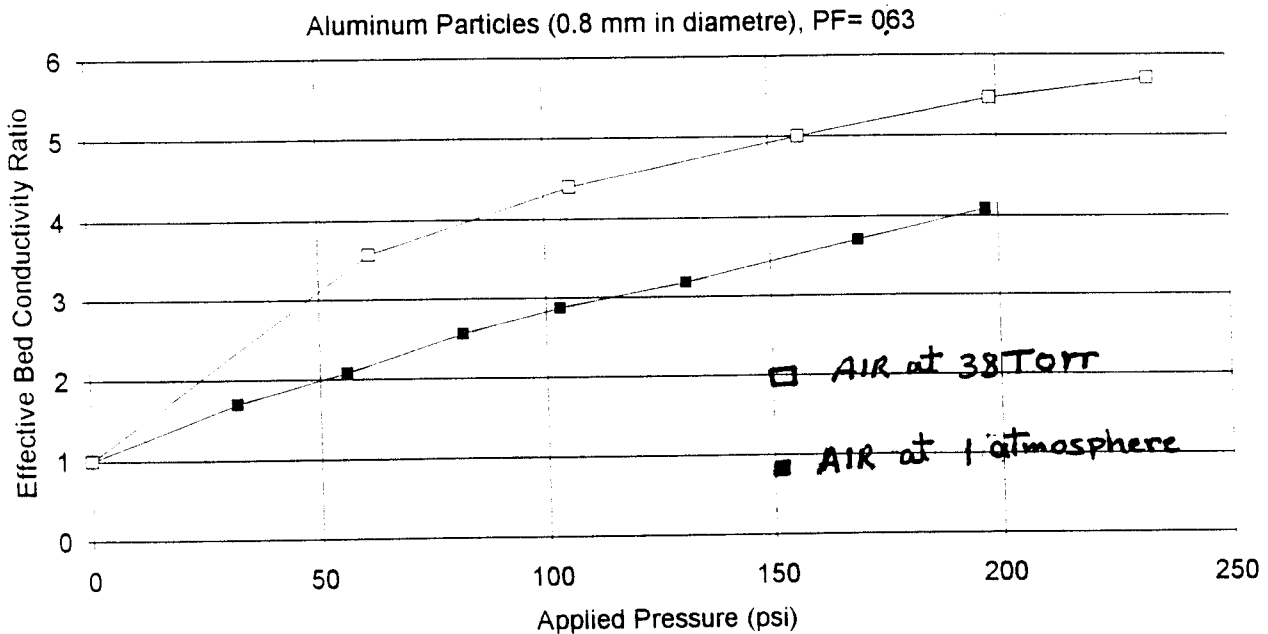
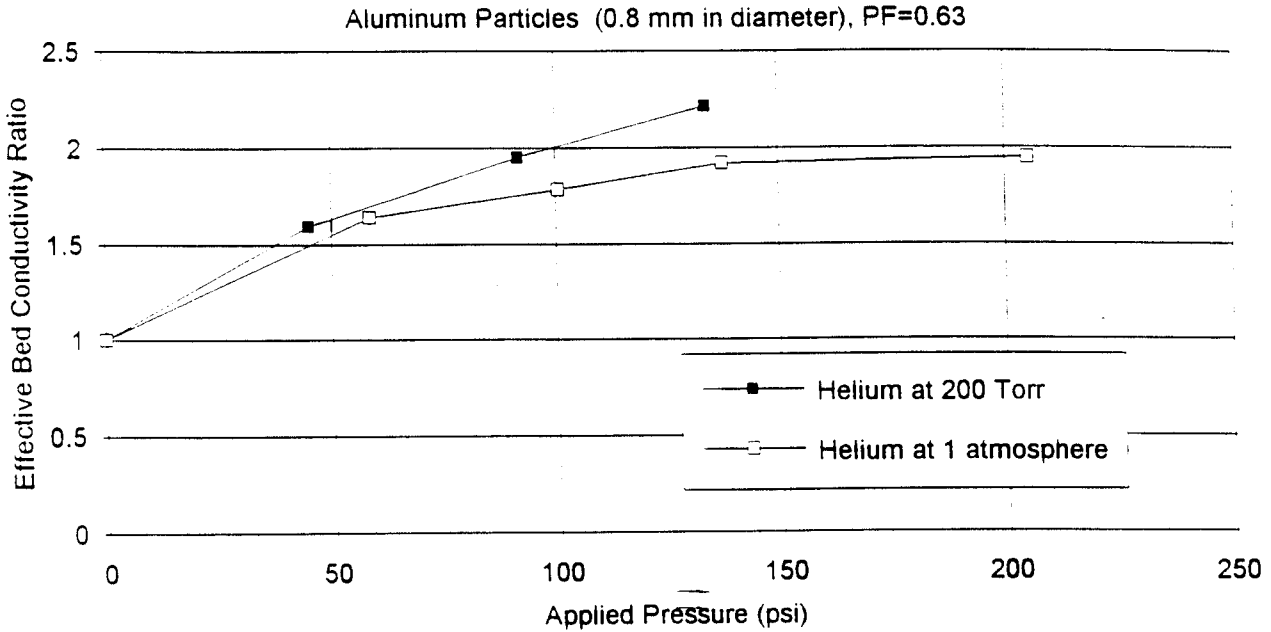

EFFECT OF EXTERNAL LOAD ON:

BERYLLIUM PARTICLE BED EFFECTIVE THERMAL CONDUCTIVITY



Beryllium Particles (2 mm in dia.), PF= 0.634

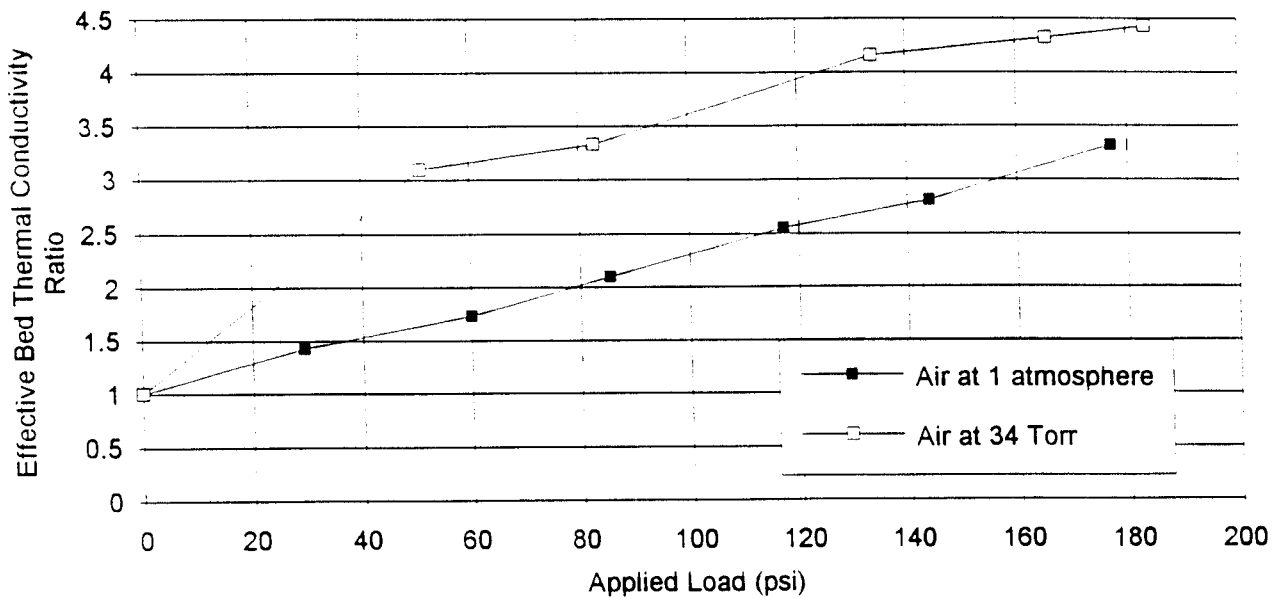
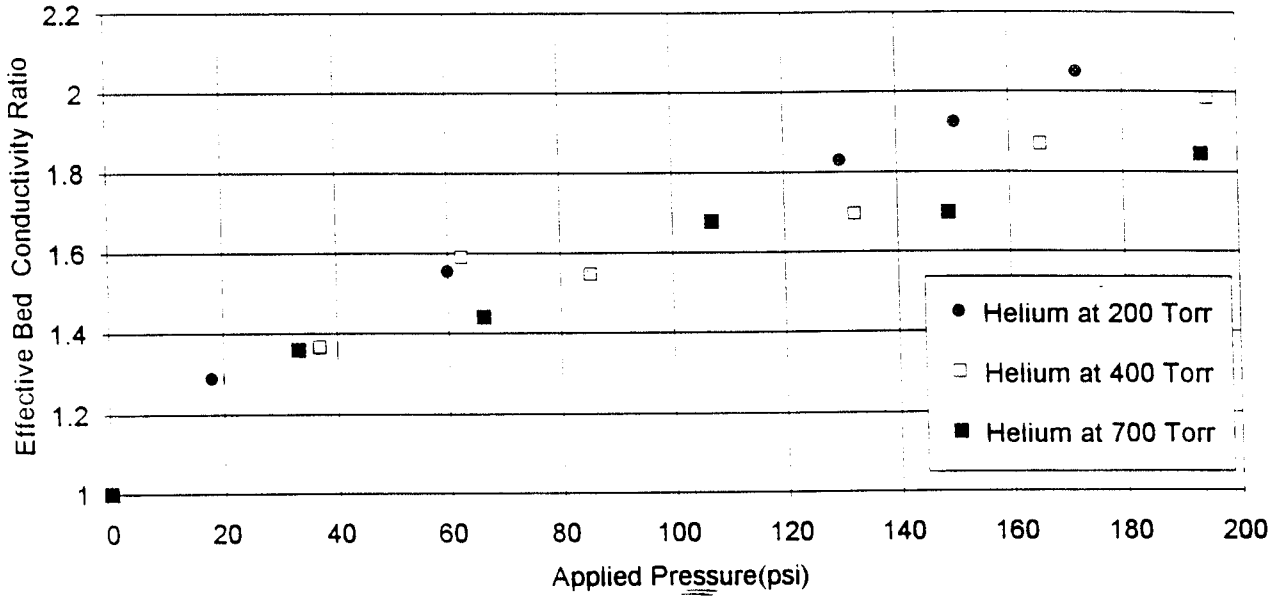

EFFECT OF EXTERNAL LOAD ON

LITHIUM ZIRCONATE PARTICLE BED EFFECTIVE THERMAL COND

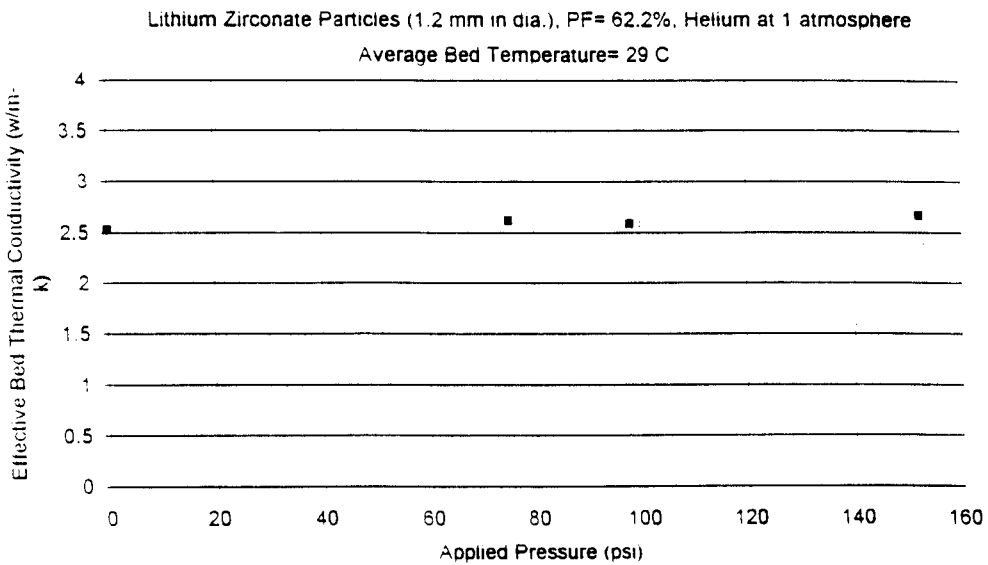
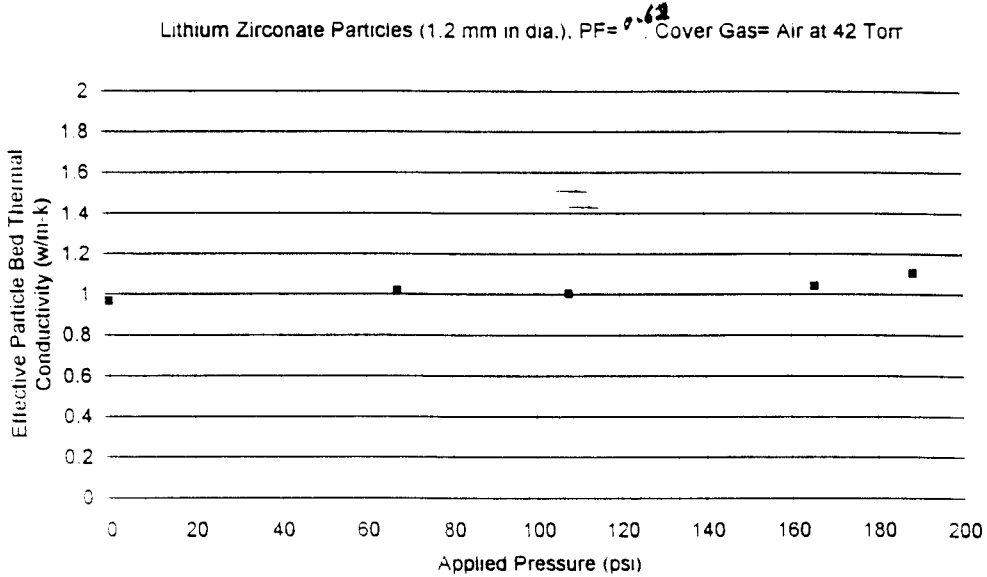
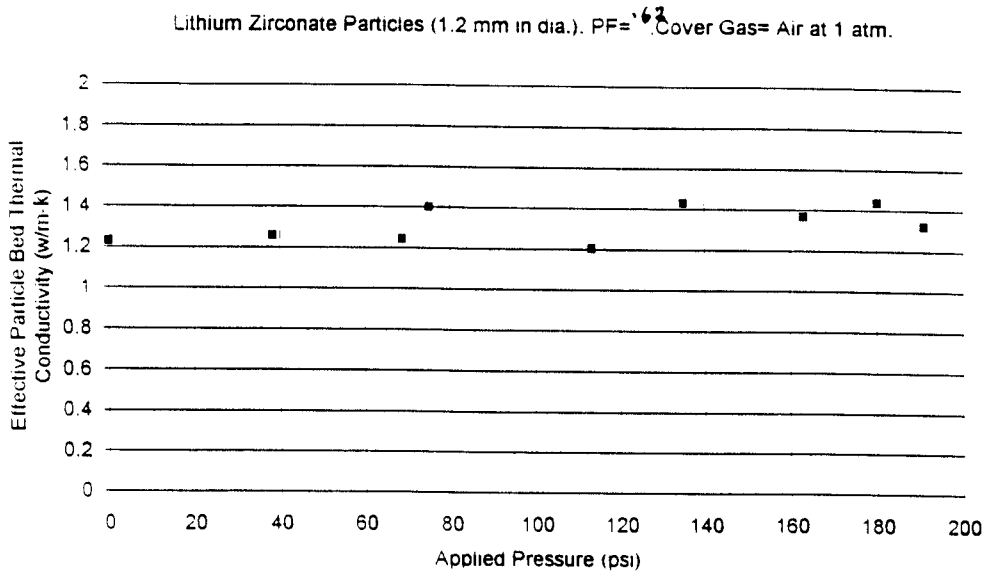

EFFECT OF TEMPERATURE ON ALUMINUM PARTICLE BED EFFECTIVE THERMAL CONDUCTIVITY

84

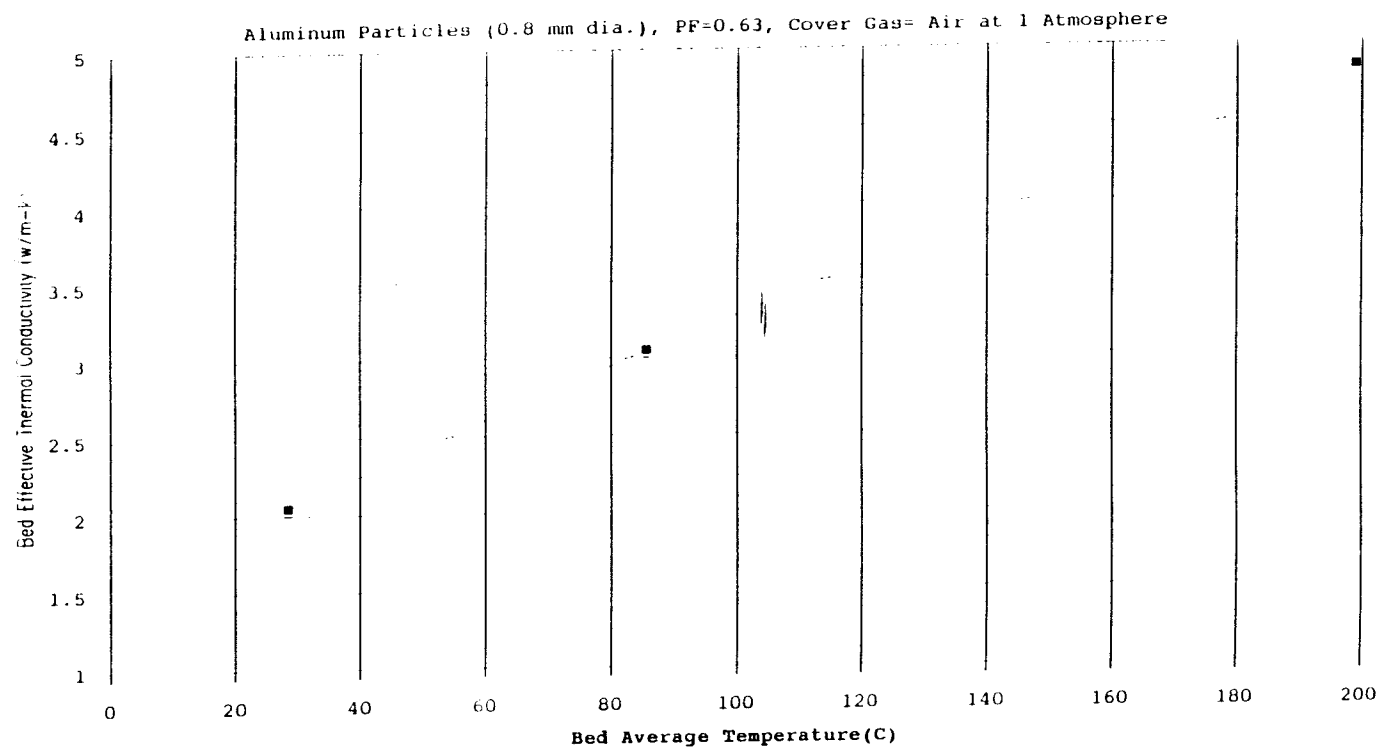

EFFECT OF EXTERNAL LOAD ON ALUMINUM PARTICLE BED EFFECTIVE THERMAL CONDUCTIVITY AVERAGE BED TEMPERATURE= 194 C

Aluminum Particles(0.8 mm in dia.), PF=0.63, CoverGas= Air at 1 atmosphere
Average Bed Temperature= 194 C

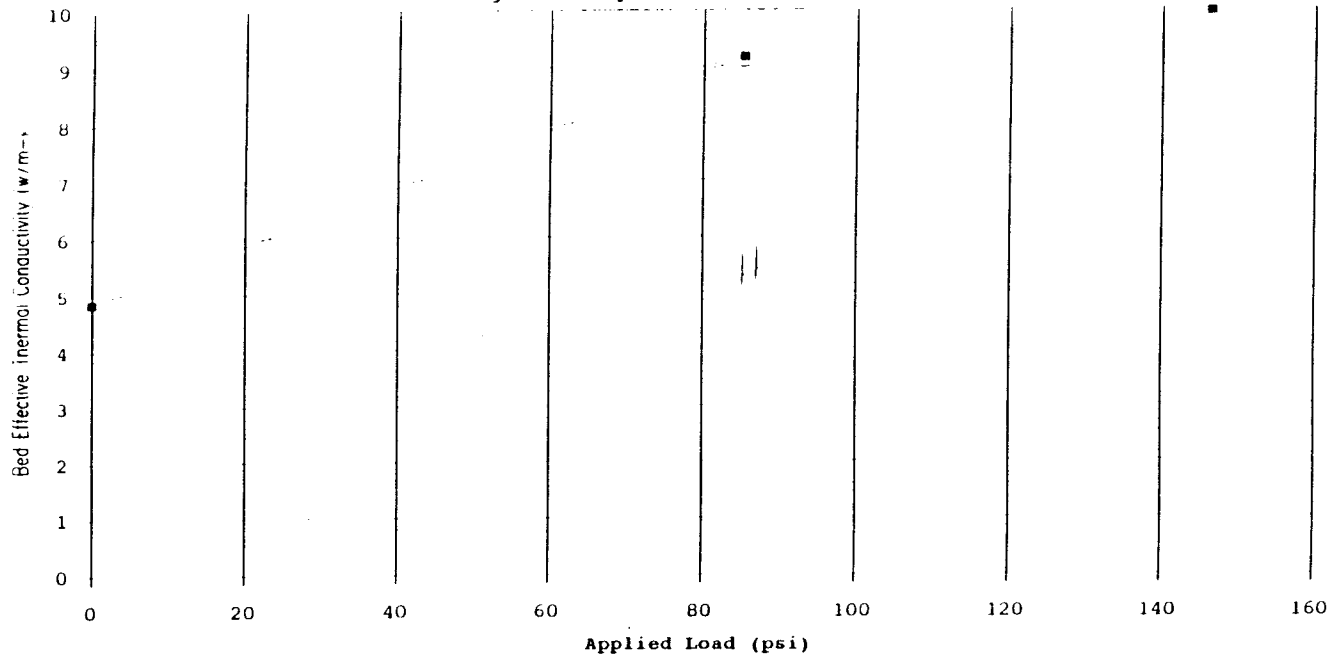

85



EFFECT OF EXTERNAL LOAD ON:

ALUMINUM PARTICLE BED/SS CLAD INTERFACE CONDUCTANCE COEFF.

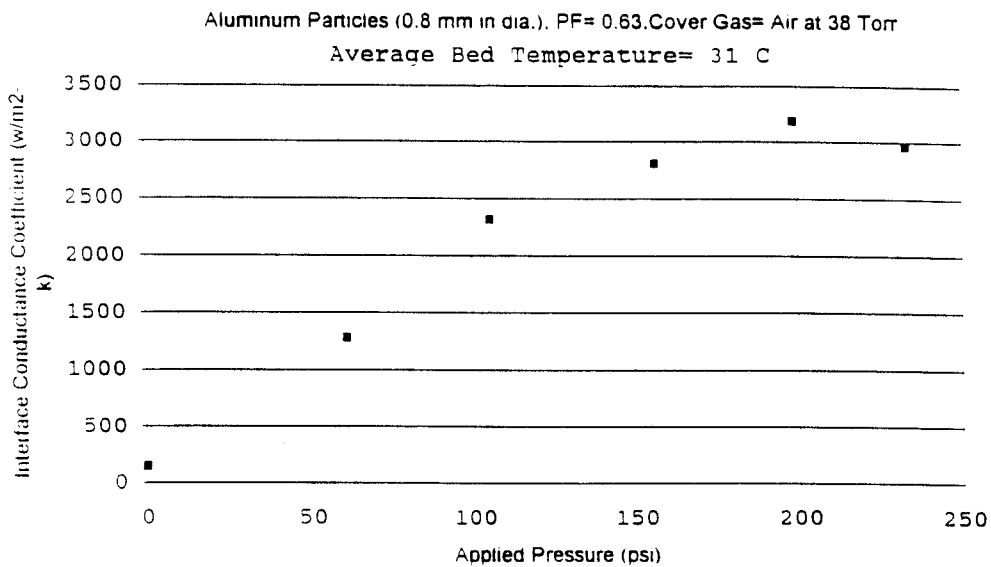
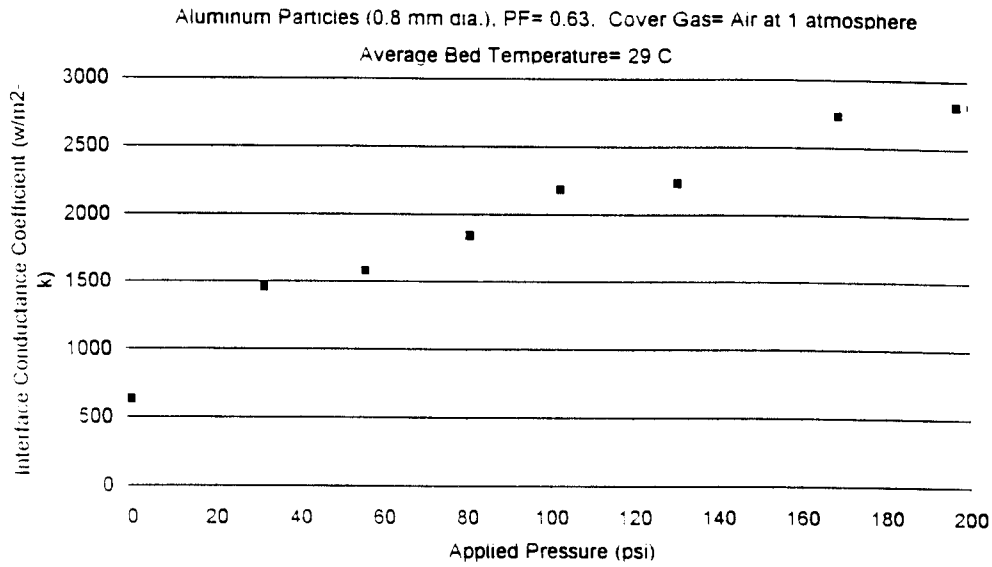



EFFECT OF EXTERNAL LOAD ON: ALUMINUM PARTICLE BED/SS CLAD INTERFACE CONDUCTANCE COEFF.

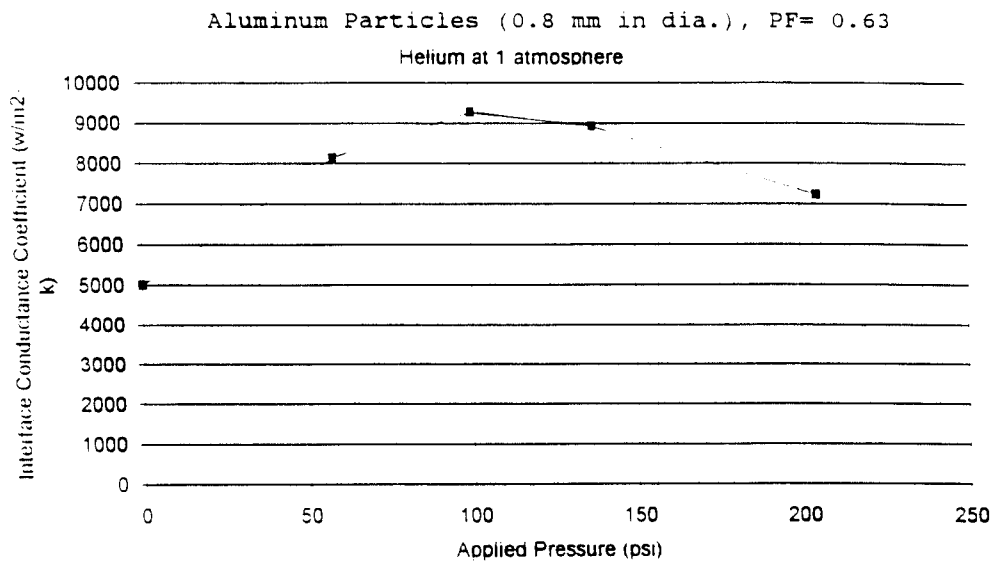
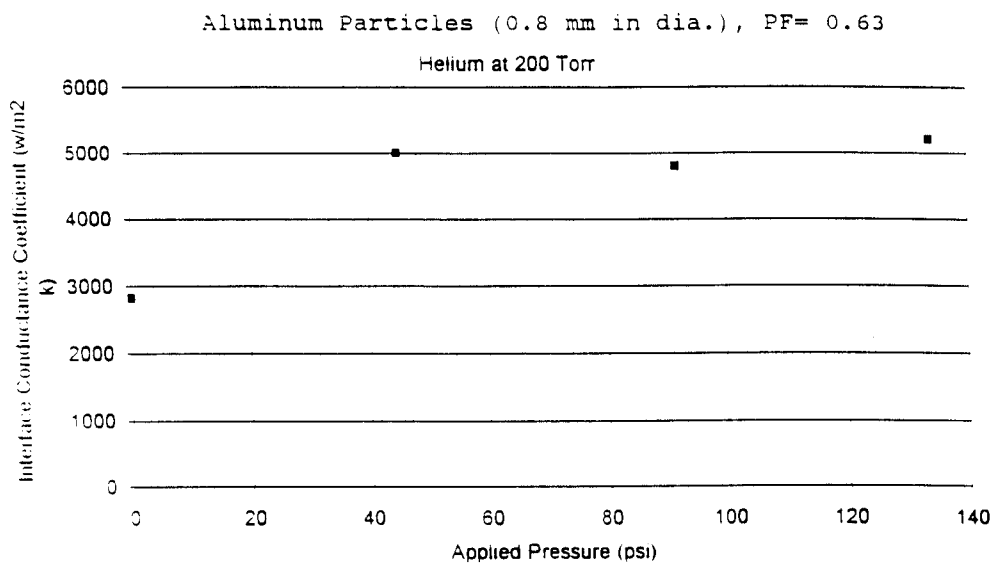



EFFECT OF EXTERNAL LOAD ON: LITHIUM ZIRCONATE PARTICLE BED/SS CLAD INTERFACE CONDUCTANCE COEFF.

Lithium Zirconate Particles (1.2 mm in dia.), PF= 62.2% . Cover Gas= Air at 42Torr

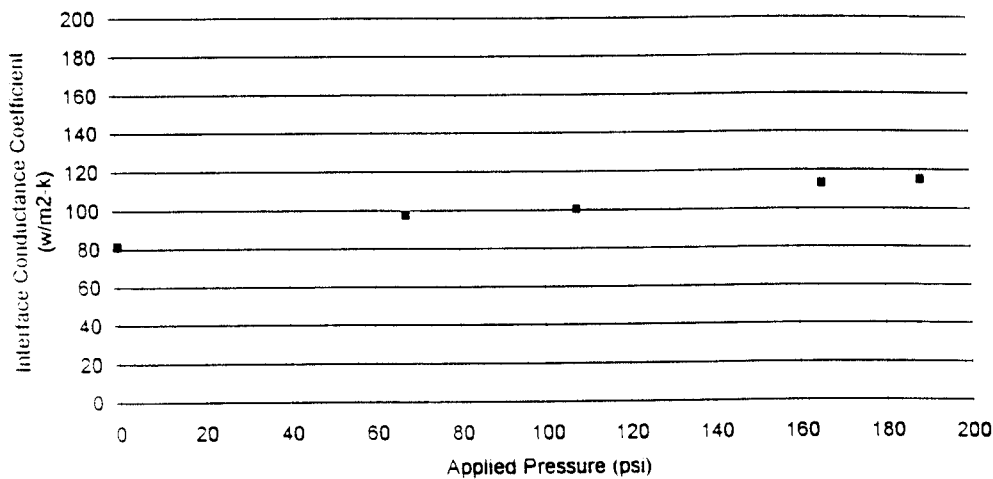

Lithium Zirconate Particles (1.2 mm in dia.), PF= 62.2% . Helium at 1 atmosphere
Average Bed Temperature= 29 C

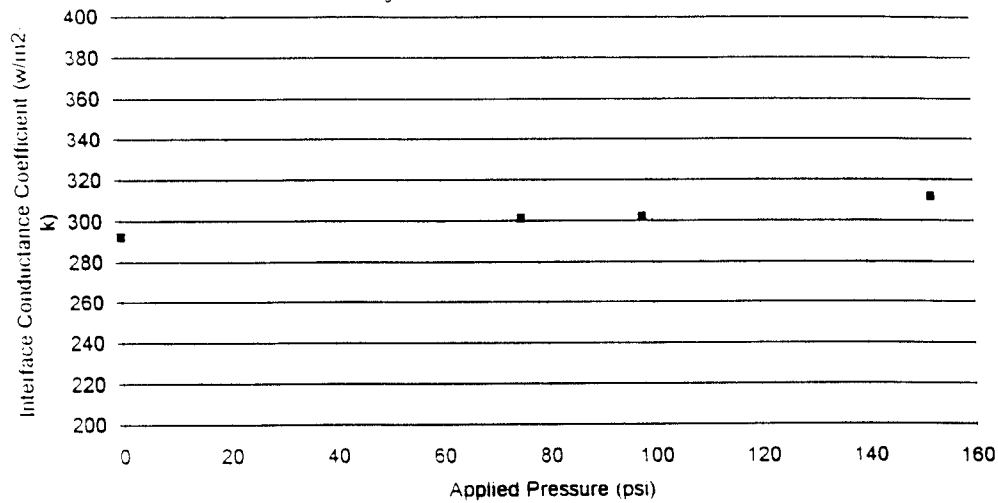



Table 2. Thermal Conductivity Ratios¹ of Aluminum, Lithium Zirconate and Beryllium Particle Beds Subjected To An External Pressure of 100 psi

Particle Type	Air Cover Gas Pressure (Torr)					Helium Cover Gas Pressure (Torr)			
	34	38	200	700	760	200	400	700	760
Aluminum		4.4			2.94	2.03			1.78
Beryllium	3.6		2.94		2.37	1.68	1.60	1.60	
Lithium Zirconate		~ 1.0			~ 1.0				~ 1.0

89

¹ (Keff)100 psi/(Keff)no load

CONCLUSIONS:

The effective bed thermal conductivities of aluminum, beryllium and lithium zirconate particles with average respective diameters of 0.8, 2, and 1.2 mm as a function of applied external load were measured. Air and Helium at pressures in the range of 32 to 760 torrs were used as the cover gas. The following conclusions were reached.

Aluminum Particle Bed (PF= 63%)

- 1) With air at atmospheric pressure as the cover gas the aluminum bed effective thermal conductivity increased by a factor of 3.7 when subjected to an external pressure of 200 psi. With the same value of the applied load with air at 38 Torr the bed effective thermal conductivity increased by a factor of 4.8.
- 2) With helium at 200 Torr and 1 atmosphere, for an applied load of 140 psi, the effective aluminum bed thermal conductivity increased by factors of 1.8 and 2.1 w/m-k respectively.
- 3) With atmospheric air as the cover gas, the effective aluminum bed thermal conductivity increased varied from 2 to 4.9 w/m-k as the average bed temperature increased from 28 to 194 C.
- 4) At an average bed temperature of 194 C and atmospheric air as the cover gas the effective bed thermal conductivity increased by a factor of ~ 2 as the external load was raised to 148 psi.
- 5) Variations in the bed/stainless steel interface conductance coefficient with the applied external load followed closely those of the bed effective thermal conductivity.



Beryllium Particle Bed (PF=63.4%)

6) The effective thermal conductivity of beryllium particle bed with air at 1 atmosphere pressure increased by a factor of 3 as the applied load was raised to 180 psi. With helium at 700 and 400 Torr pressures and an applied load of 190 psi, the bed effective thermal conductivity increased by a factor of 1.75 and 1.68 respectively.

Lithium Zirconate Particle Bed (PF=62%)

7) No measurable change in the lithium zirconate effective bed thermal conductivity was observed when subjected to external loads of 0 to 250 psi with air and helium as the cover gas.

8) No measurable change in the lithium zirconate bed /stainless steel interface conductance coefficient was observed when subjected to external loads of 0 to 250 psi with air and helium as the cover gas.

General Conclusions

Effective thermal conductivity of packed beds increases when subjected to external loadings

The degree of increase in the particle bed effective thermal conductivity for the range of 0-250 psi external load is a strong function of the solid-to-gas conductivity ratio.

The changes in the particle bed/stainless steel interface conductance coefficient when subjected to external loads in the range of 0-250 psi is a function of the solid-to-gas thermal conductivity ratio and follows closely the changes in the bed effective thermal conductivity

16

Liquid Metal Divertor
Experiments and Modeling

Liquid Metal Divertor Designs

Concepts and Issues

LM advantages:

- protect solid surfaces from plasma
- reduce/eliminate thermal stresses in structure

Design concepts:

- film flow over a solid substrate *
- droplet screens
- stagnant pools
- seeping films through porous substrate

Design issues:

- sufficient film thickness or screen integrity (normal/off-normal reactor conditions) *
- contamination of main plasma *
- formation and collection *
- tritium retention and inventory *
- heat removal capability *

* UCLA activities

Objectives of UCLA Activity

MHD film flow modeling

- film height evolution down the channel
 - function of field, geometry, conductivity, and LM
 - avoid flooding, dry-out, and detachment
- fully developed velocity profiles
 - heat transfer and channel averaging
- stability limits of film surface

Film flow experiments

- construction of facility: MEGA-loop
 - completed April 1993
- demonstrate ability to control film shape
 - small chute (9 cm)
 - moderately large (30 cm) chute
 - surface tension effects
 - viscous effects (Ha layer friction)
 - low interaction regime
- generate empirical data for design vs. key parameters
 - angle of chute
 - flow rate
 - channel width
- develop and validate predictive capability

Future: Test alternative configurations
former/collector/channel
Stability

Film Flow Modeling

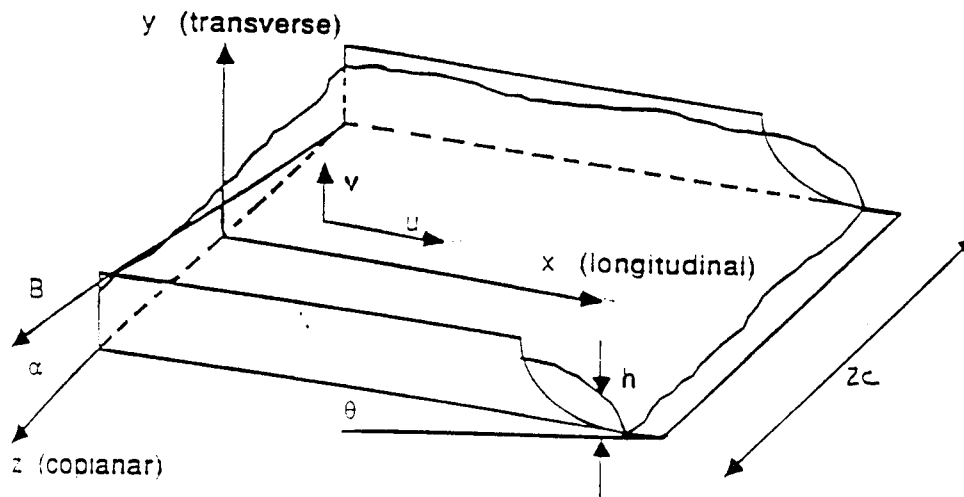

Film height evolution and stability

- basic equations in 2-D derived from Navier-Stokes

$$\frac{\partial \mathbf{u}}{\partial t} + u \frac{\partial \mathbf{u}}{\partial x} + v \frac{\partial \mathbf{u}}{\partial y} = \frac{\sin \theta}{Fr^2} - \frac{\cos \theta}{Fr^2} \frac{\partial h}{\partial x} + \frac{We}{Fr^2} \frac{\partial^3 h}{\partial x^3} + \frac{1}{Re} \left(\frac{\partial^2 \mathbf{u}}{\partial x^2} + \frac{\partial^2 \mathbf{u}}{\partial y^2} \right) - \Lambda \mathbf{u}$$

$$\frac{\partial \mathbf{u}}{\partial x} + \frac{\partial \mathbf{v}}{\partial y} = 0, \quad \int_0^h \mathbf{u} \, dy = q$$

- film height solved numerically
- stability solved for longwaves using successive expansion

2-D Fully developed velocity

- basic equations in 2-D derived from Navier-Stokes and the magnetic induction

$$\frac{\partial^2 \mathbf{u}}{\partial y^2} + \beta^2 \frac{\partial^2 \mathbf{u}}{\partial z^2} + Ha \, \mathbf{b} \left(\sin \alpha \frac{\partial \mathbf{b}}{\partial y} + \beta \cos \alpha \frac{\partial \mathbf{b}}{\partial y} \right) = \frac{Re}{Fr^2} \sin \theta$$

$$\frac{\partial^2 \mathbf{b}}{\partial y^2} + \beta^2 \frac{\partial^2 \mathbf{b}}{\partial z^2} + Ha \, \mathbf{b} \left(\sin \alpha \frac{\partial \mathbf{u}}{\partial y} + \beta \cos \alpha \frac{\partial \mathbf{u}}{\partial y} \right) = 0$$

- velocity and induced field profiles solved numerically

MEGA Loop Major Components

ab

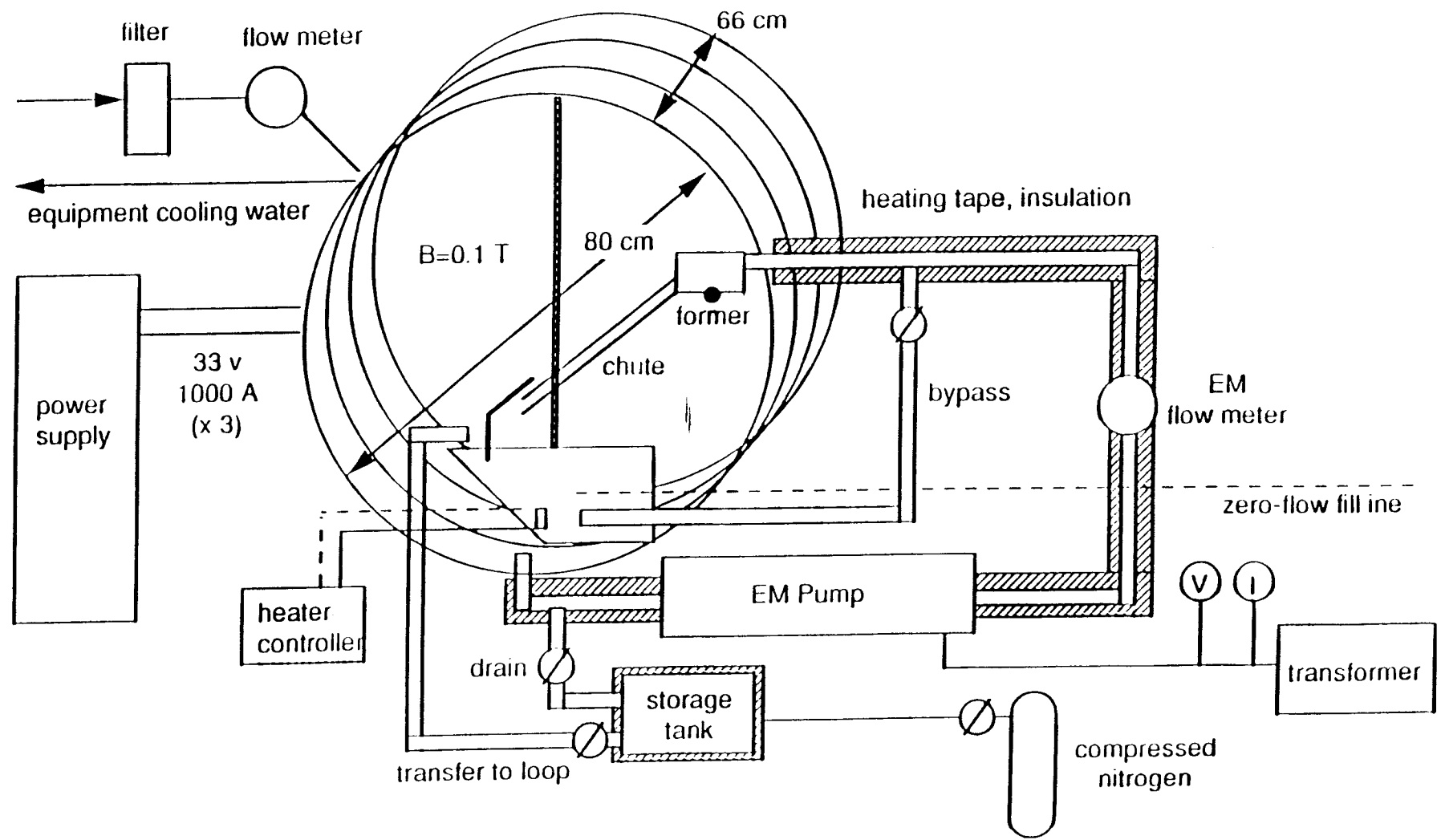

MEGA Loop Parameters

Maximum Flow Rate	F	1.5	l/s
Loop Volume	V	15	l
Transit Time	τ	10	s
Pumping Pressure	Δp	350	kPa
Pump Input Power	P	13	kW
Max. Field (axis)	B	1.8	kG

Properties of Bi-Pb Alloy

Composition 0.447 Bi, 0.226 Pb, 0.191 In, 0.083 Sn, 0.050 Cd

Density ρ 9160 kg/m³

Melting Point mp 47 ~~°C~~

Heat of Fusion Hf 14000 J/kg

Volume Change ΔV_{l-s} -1.4 %

(liquid→solid)

Dynamic Viscosity μ 1.7×10^{-3} kg/m-s *

Kinematic Viscosity ν 1.86×10^{-7} m²/s *

Specific Heat C_p 146.6 J/kg-K **

Electrical Cond. σ 1.82×10^6 1/ Ω -m **

Thermal Cond. k 25 W/m-K *

* estimated from similar LM alloy data

** manufacturer data for solid phase

Test Plan

- measure 2-D surface height and electric potential
- perform measurements under a range of chute angles and flow rates
- repeat measurements with different duct widths
- chart stability limits

Chute Configuration and Instrumentation

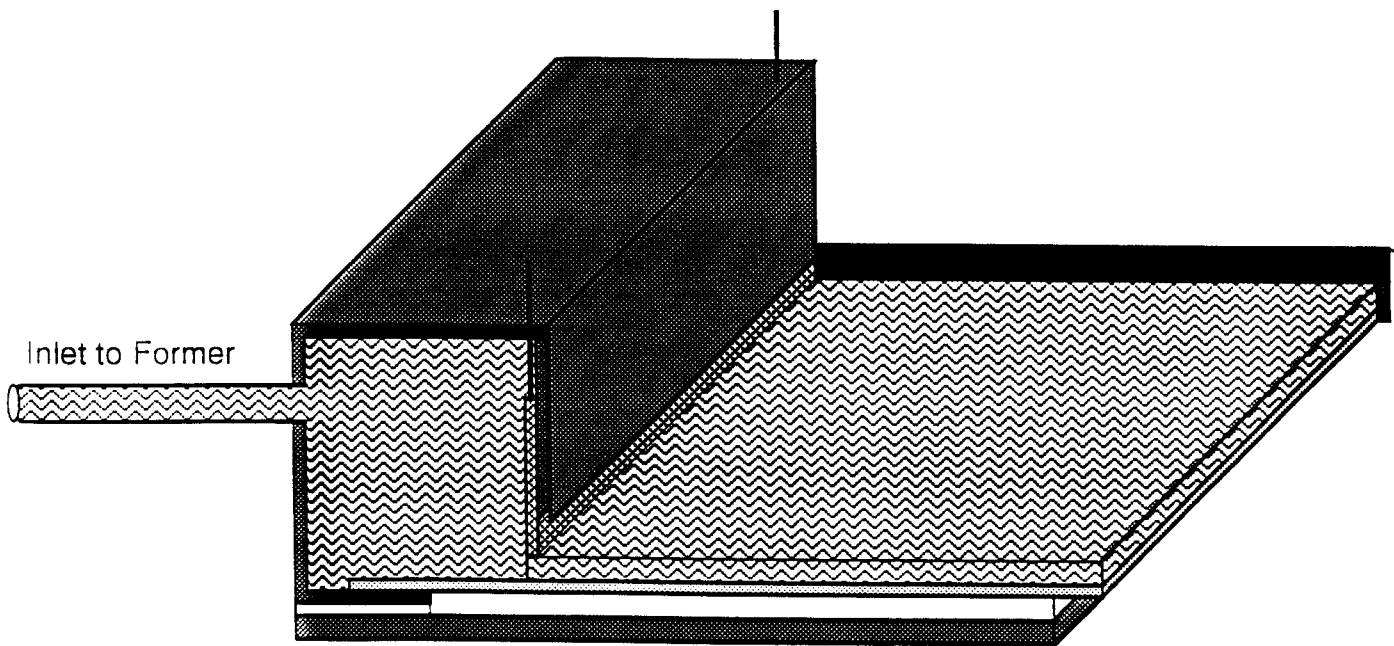
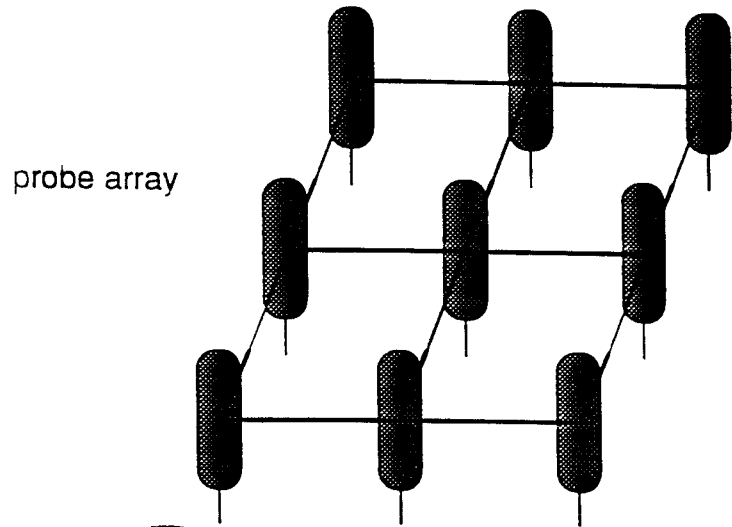
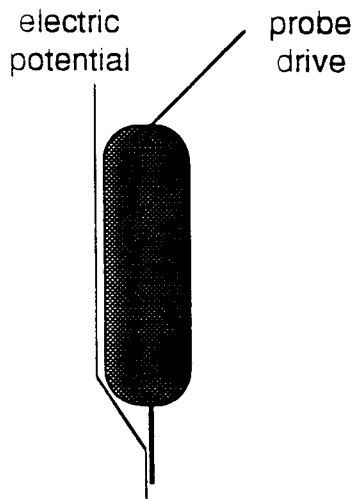

Phase Change Divertor Cooling

==

Innovative Technique for High Heat Flux Removal in ITER Divertor

- During the CDA phase, divertor loads of up to 20-30 MW/m² were estimated for normal ITER operation
- These heat load levels tend to require the use of high-pressure cooling systems in combination with high heat flux enhancement techniques, such as the use of twisted tapes with subcooled water coolant and microfins with He.
- As a possible alternative, we are proposing a simple, innovative, low-to-moderate-pressure coolant system with high heat flux removal capability: *the Phase-Change Fluid and Particulate Flow (PCFPF) system*
- The coolant would consist of a mix of single-phase or boiling fluid and phase-changing particulates. The particulates can be solid and undergo melting and even vaporization, or liquid and undergo vaporization.
- An example of such a system is the subcooled boiling water-ice particulate flow

Effect of Ice Particulates in the Water Coolant on the Critical Heat Flux(CHF)

- **The Presence of Ice Particulates in the Water Coolant Could Potentially Increase the CHF in a Number of Ways, Including:**
 1. **Maximizing the inlet subcooling**
 2. **Allowing for higher heat fluxes through ice melting**
 3. **Enhancing the mixing process between the coolant bulk and the wall region through ice particulate motion and interaction with wall surface and bubbles (The extent of which would need to be determined through detailed analytical and experimental studies)**
- **To be conservative, only the first two effects were considered in the initial analysis**

CHF(Bowring) as a Function of Mass Velocity for Inlet Pressures of 2 and 30 bar
The Heat Flux required to Melt a 40% Ice Mass Fraction is Also Shown.

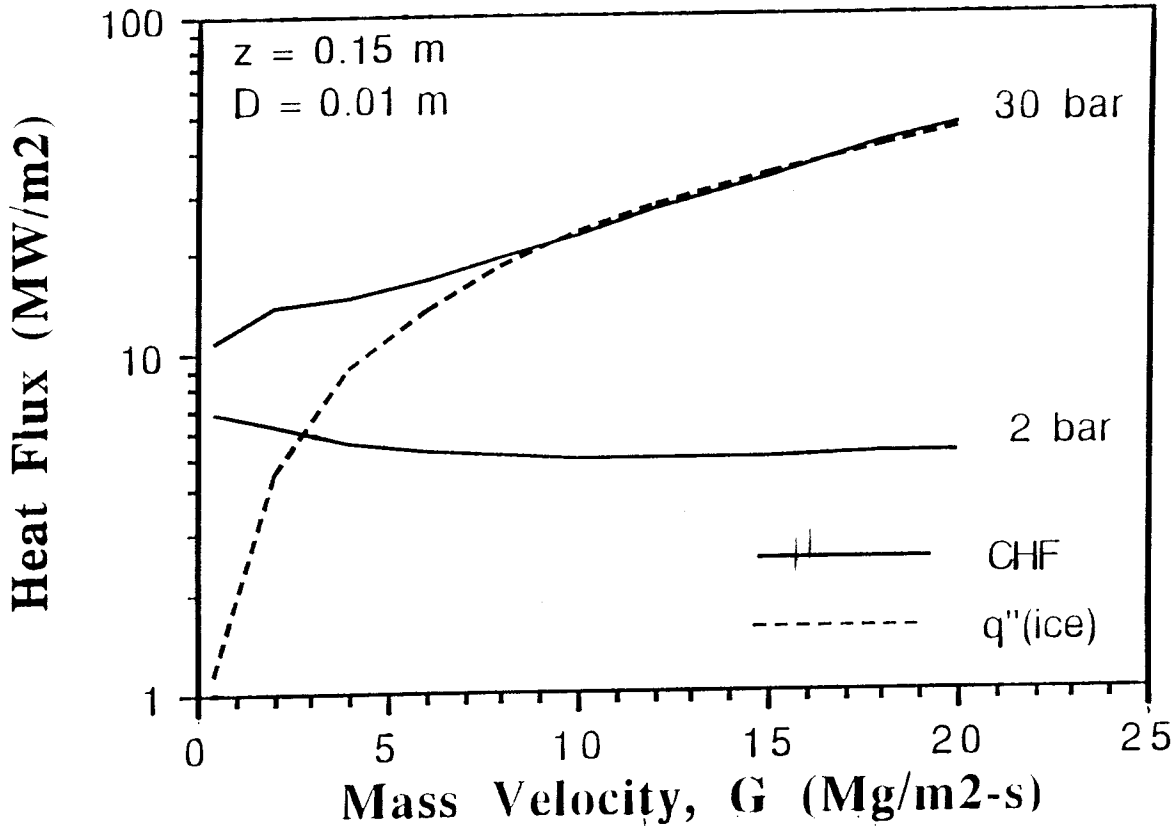

Preliminary Analysis of Subcooled Boiling Water/ Ice Particulates System

- The proposed cooling system has good potential for HHF removal capability (order of 10's MW/m²) at low-to-moderate system pressure (1-10 bar).
- The cooling system seems most effective for low ratios of tube length to diameter ($z/D \sim 20$ or less), and for relatively small surface areas to be cooled, based on reasonable pressure drop and refrigeration power requirement.
- Typical application would be the ITER divertor, e.g. for the following assumed divertor parameters:
 - surface area = 200 m²;
 - total heat load = 100 MW;
 - peak power densities = 20 MW/m² over a poloidal thickness of 24 cm based on separatrix sweeping;
 - $z/D = 24$ for poloidal flow in 1-cm tube;
 - $P = 2$ bar;
 - $G = 15,000$ kg/m²-s;

CHF(Bowring) = 4.8 MW/m²
 $q''(\text{ice melting}) = 16$ MW/m² for $\beta=0.3$
Refrigeration power ~ 10 -20 MW
 $\Delta P \sim 0.6$ bar

105

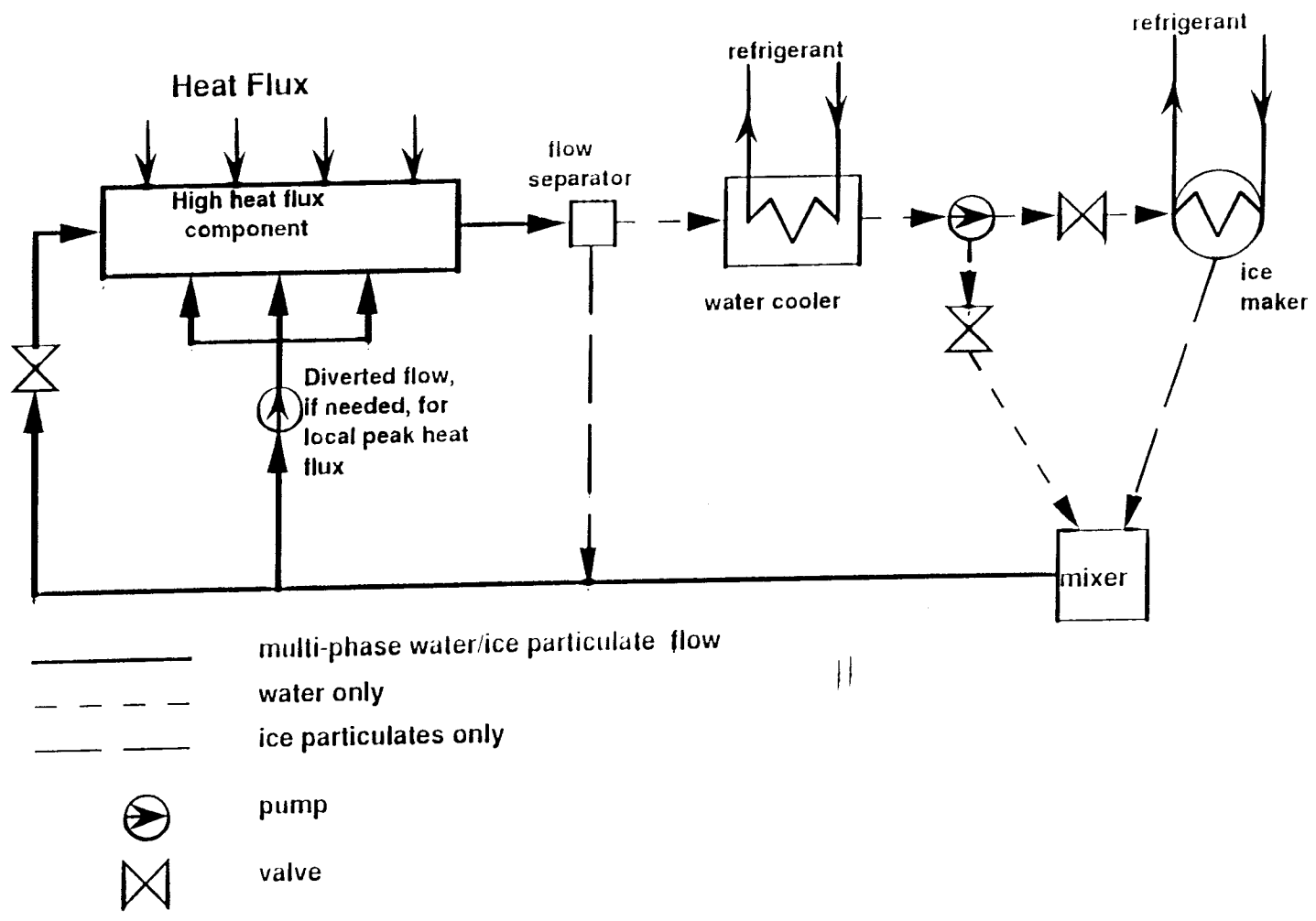

Schematic of Proposed Particulate-Phase-Change Cooling System

Phase-Change Fluid and Particulate Flow system: Conclusions

- **Based on the results of the initial analysis, we are very encouraged by the potential of this cooling system for ITER divertor application, and we have:**
 - initiated the procedure for filing a patent; and
 - submitted a technical note which was accepted for publication in the July 93 issue of Fusion Technology, with positive comments from the reviewers

- **However, there are issues that need to be addressed, including:**
 - better determination of effect of particulate interaction on heat transfer and pressure drop;
 - experimental demonstration of the system;
 - structural performance at particulate flow temperature;
 - ice production system size and cost for the case of subcooled boiling water/ice particulate system.

- **We propose to further develop this innovative cooling concept and, through detailed studies, to:**
 - thoroughly evaluate its performance, including determination of optimum operating conditions and material combination choices; and
 - assess its attractiveness for ITER divertor application